

High Voltage Leak Detection (MicroCurrent). HVLD^{MC}

- Case Study: HVLD with Albumin Solution
- Case Study: HVLD Vs. Vacuum Decay with Albumin Solution

PDA, Basel 31 May- 1 June 2022

Tatiana Simental
CCIT General Manager



Microcurrent HV

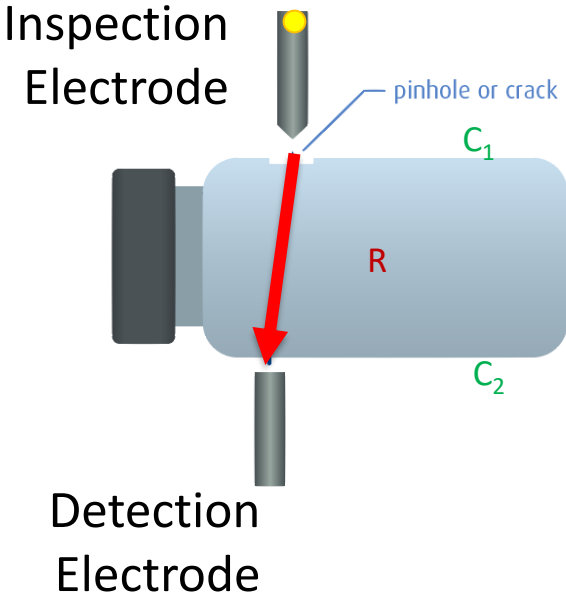
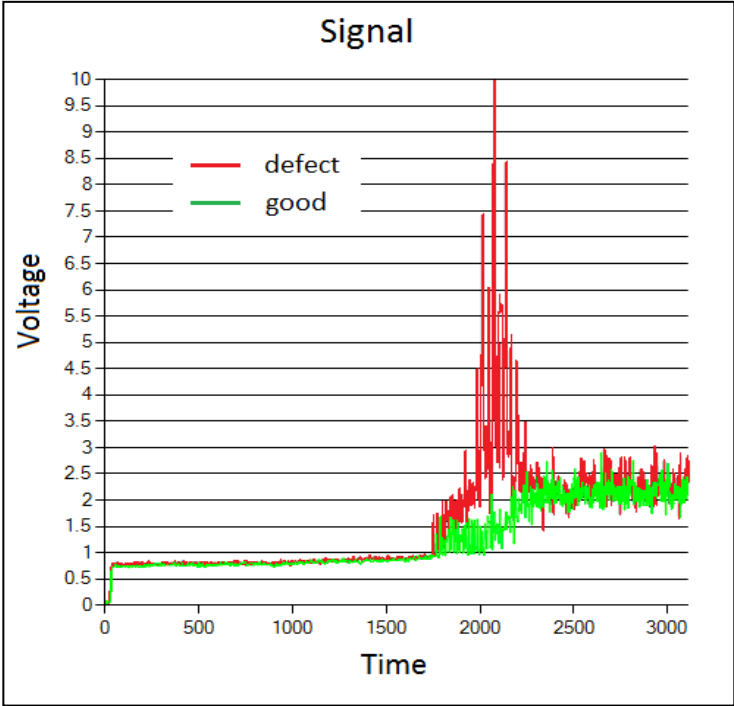

Functional Principle of HVLD^{mc} Test

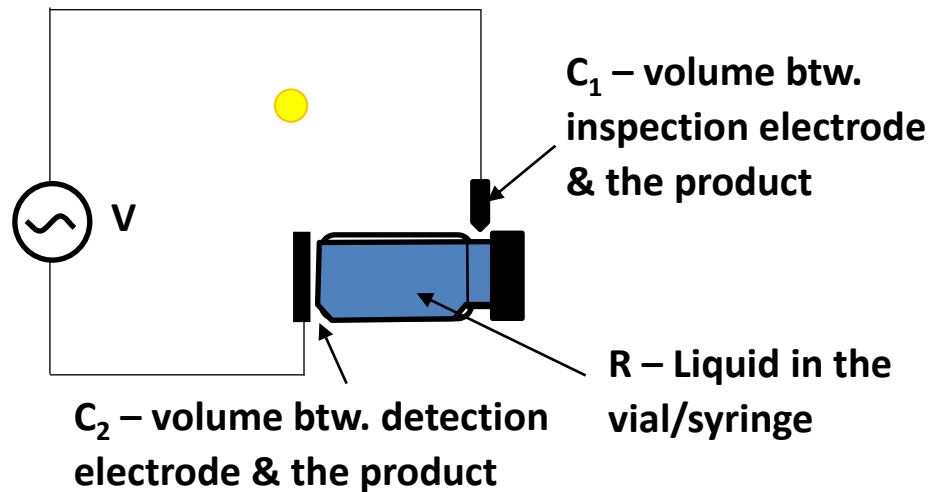

Good Sample

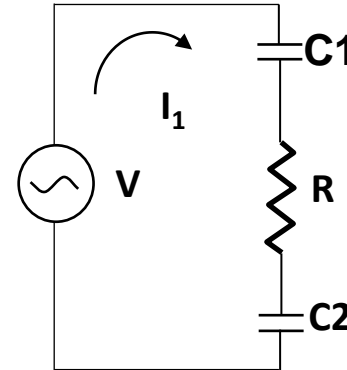

2 capacitors

Leak

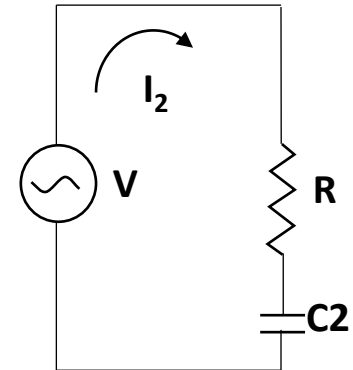

1 capacitor

V – High Voltage Source

R – Electric Resistance of the product

C_1 – Capacitor 1: Glass between the inspection electrode and product

C_2 – Capacitor 2: Glass between the detection electrode and product

I_1 – current produced when product container is sealed

I_2 – current produced when product container is defective

High Voltage Leak Detection (Microcurrent).

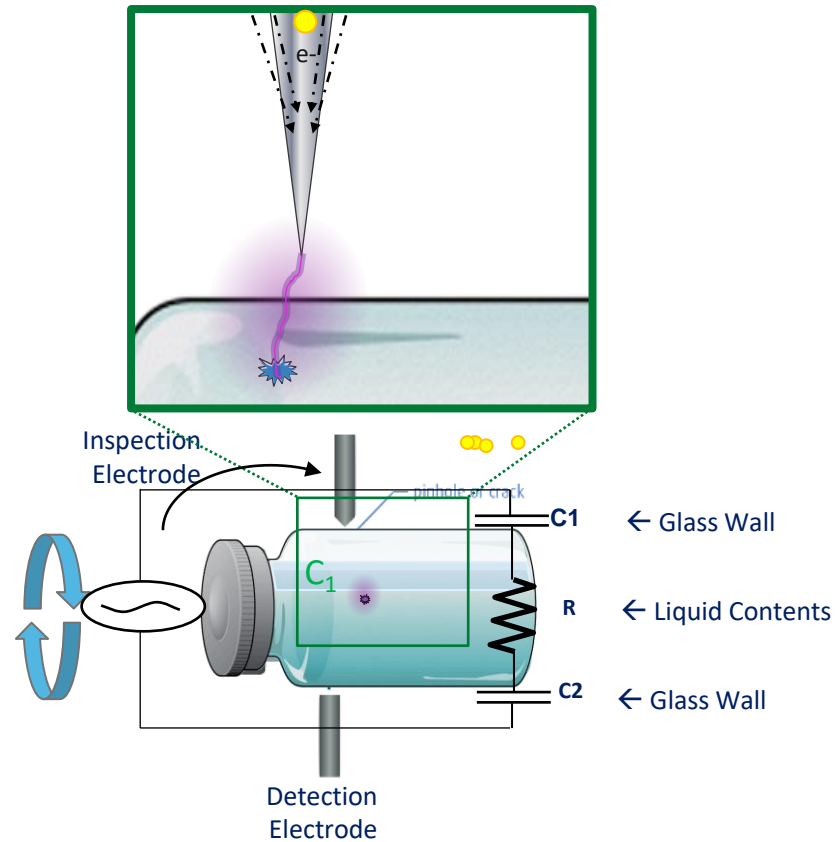
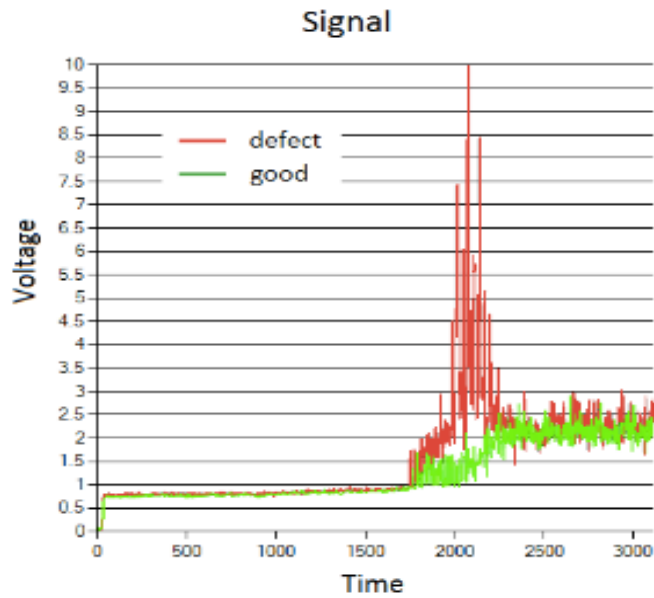

Voltage results for Negative and Positive Controls

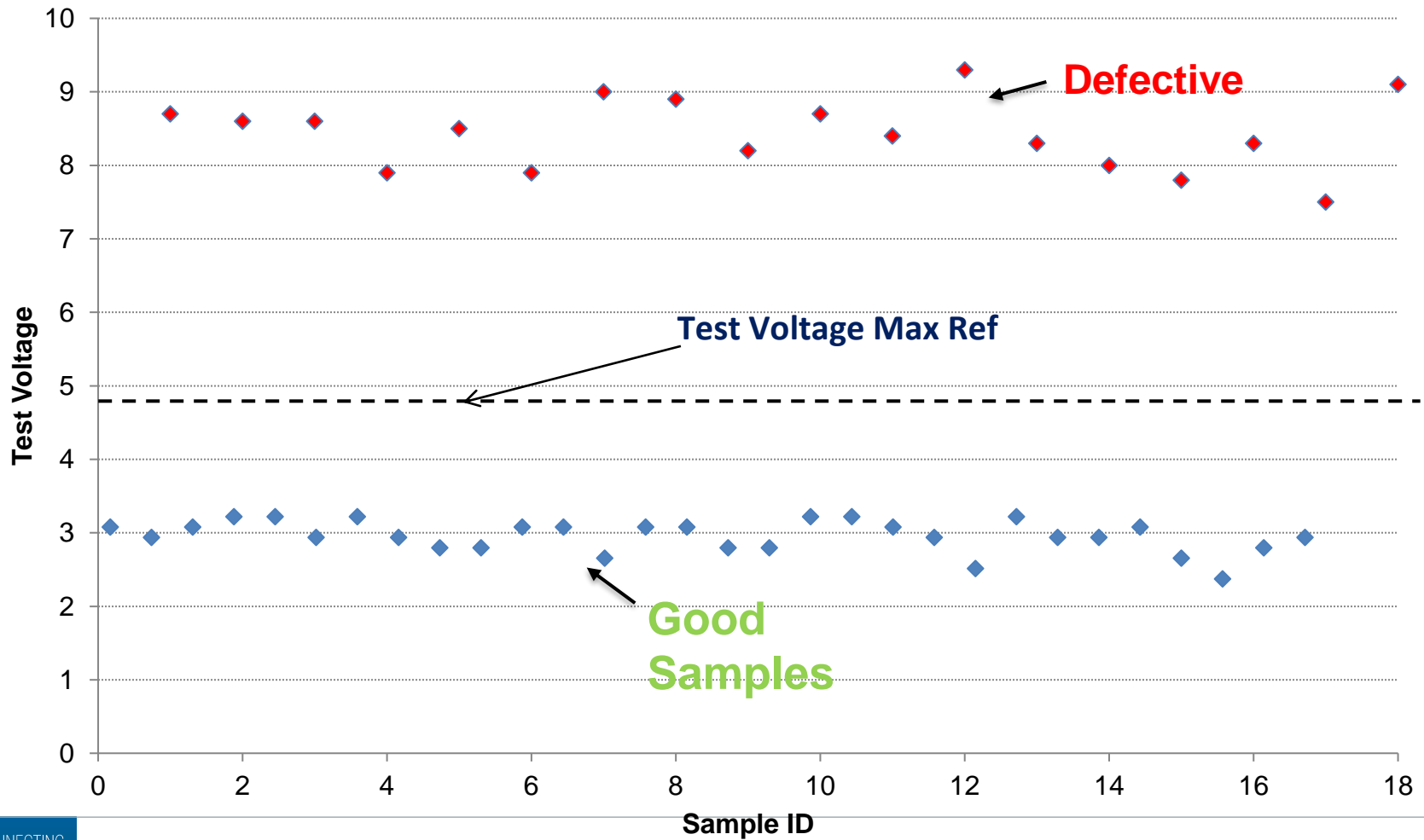

Conventional vs Microcurrent^{mc}

This new technology applies less than **50% of the voltage** used with conventional high voltage technologies and the product its exposed to less than a **5% of the voltage exposure** experienced when testing with comparable HVLD solutions.

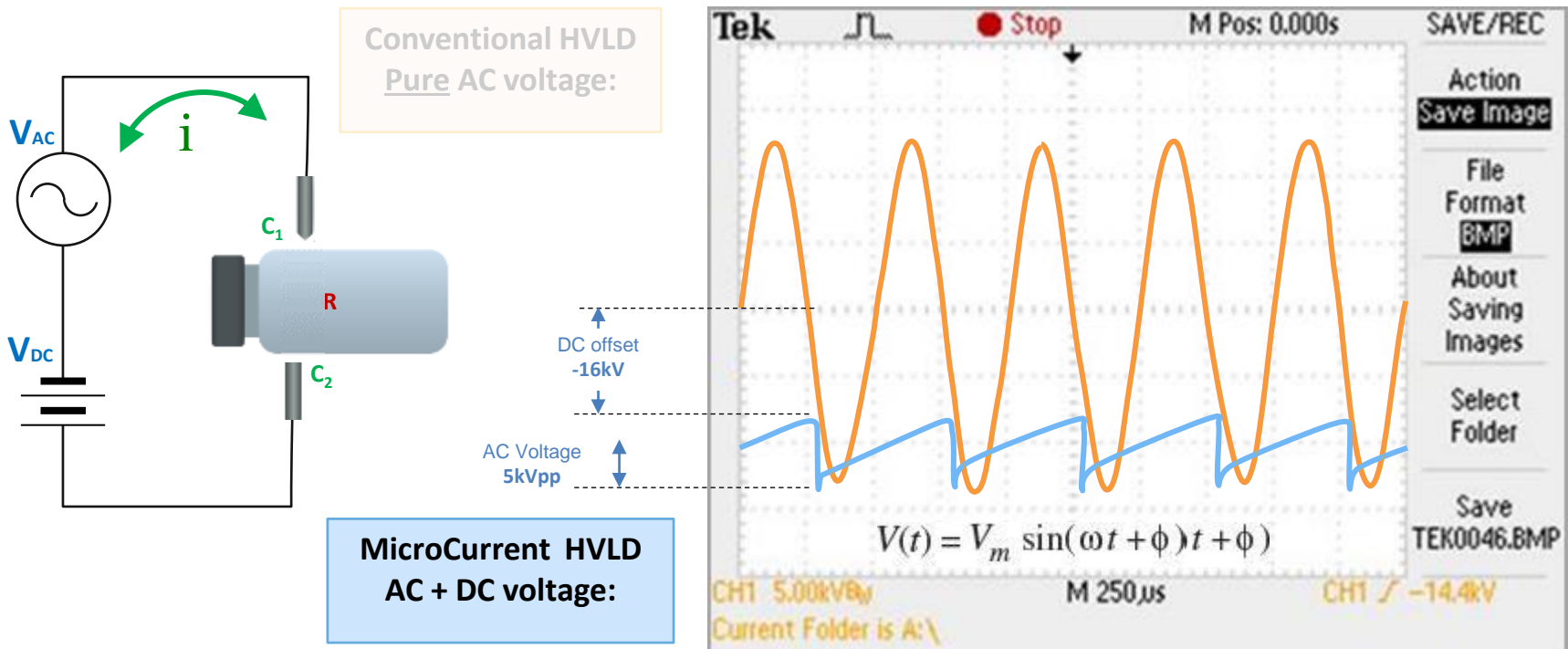

Product HV Exposure

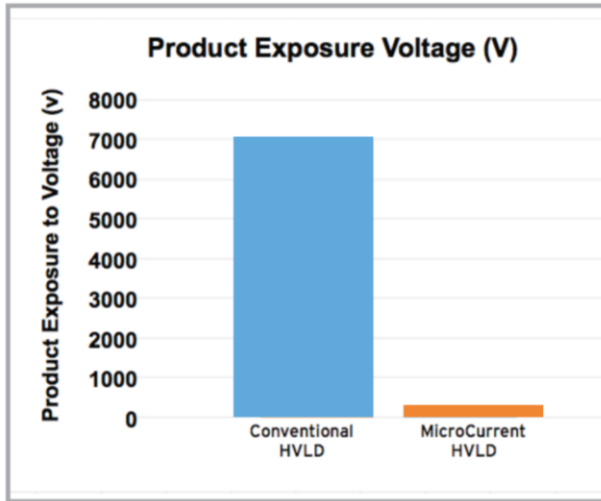

Ozone Creation

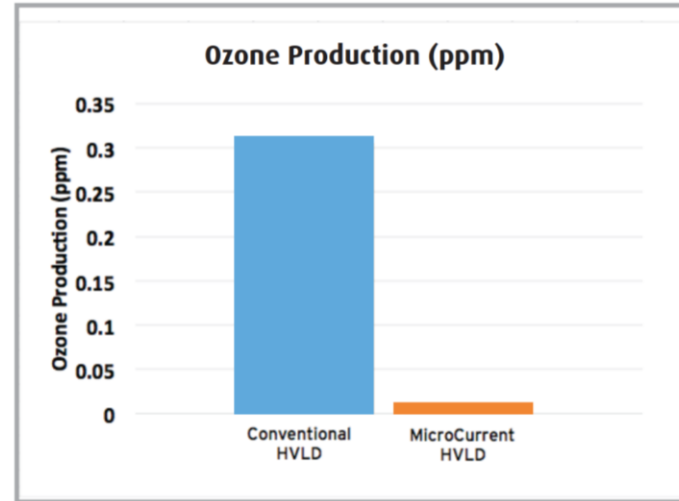

10 minutes test
Outside the product

	Conventional HVLD	MicroCurrent HVLD
Exposure Voltage (V)	7000	300
Ozone Production (ppm)	0.305	0.006

Misconceptions between

Conventional AC based HVLD vs. MicroCurrent HVLD^{mc}

- With MicroCurrent HVLD^{mc} the product is not exposed to HV (200-300V vs 7'000 – 10,000V+)
- No Ozone is created inside the package
- The current through the product is 2 - 3'000 times less than with conventional AC based HVLD systems >>> MicroCurrent
- MicroCurrent HVLD^{mc} can measure low conductivity products - < 1 micro Siemens
- MicroCurrent HVLD^{mc} can inspect products containing alcohol
- MicroCurrent HVLD^{mc} is capable of inspecting small Packages with low fill levels
- MicroCurrent HVLD^{mc} does not adversely affect proteins
- MicroCurrent HVLD^{mc} can detect defects under the crimping
- MicroCurrent HVLD^{mc} can detect clogged cracks

Case Studies:

- HVLD^{mc} with Albumin Solution (1,2,3 and 66 days)
- HVLD^{mc} vs. Vacuum Decay with Albumin Solution



Case Study 1: HVLD with Albumin Solution (1,2,3 and 66 days)

- ✓ **2R (4ml capacity) glass vials**
- ✓ **13mm Teflon faced stopper, Flip Off Seal 13 mm**
- ✓ **Positive Controls: 5, 10 und 15 μ m laser drilled holes, neck and bottom**
- ✓ **3 positive control samples of each hole size and position**
- ✓ **4 rounds of testing; 3 consecutive days, and one round 66 days later in different locations (NY-CH).**
- ✓ **Fill volume was 3ml 20% Albumin solution for both PC and NC groups. Vials were filled prior to testing, stoppered and crimped.**

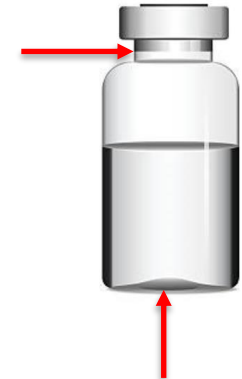

Case Study 1: HVLD with Albumin Solution (1,2,3 and 66 days)

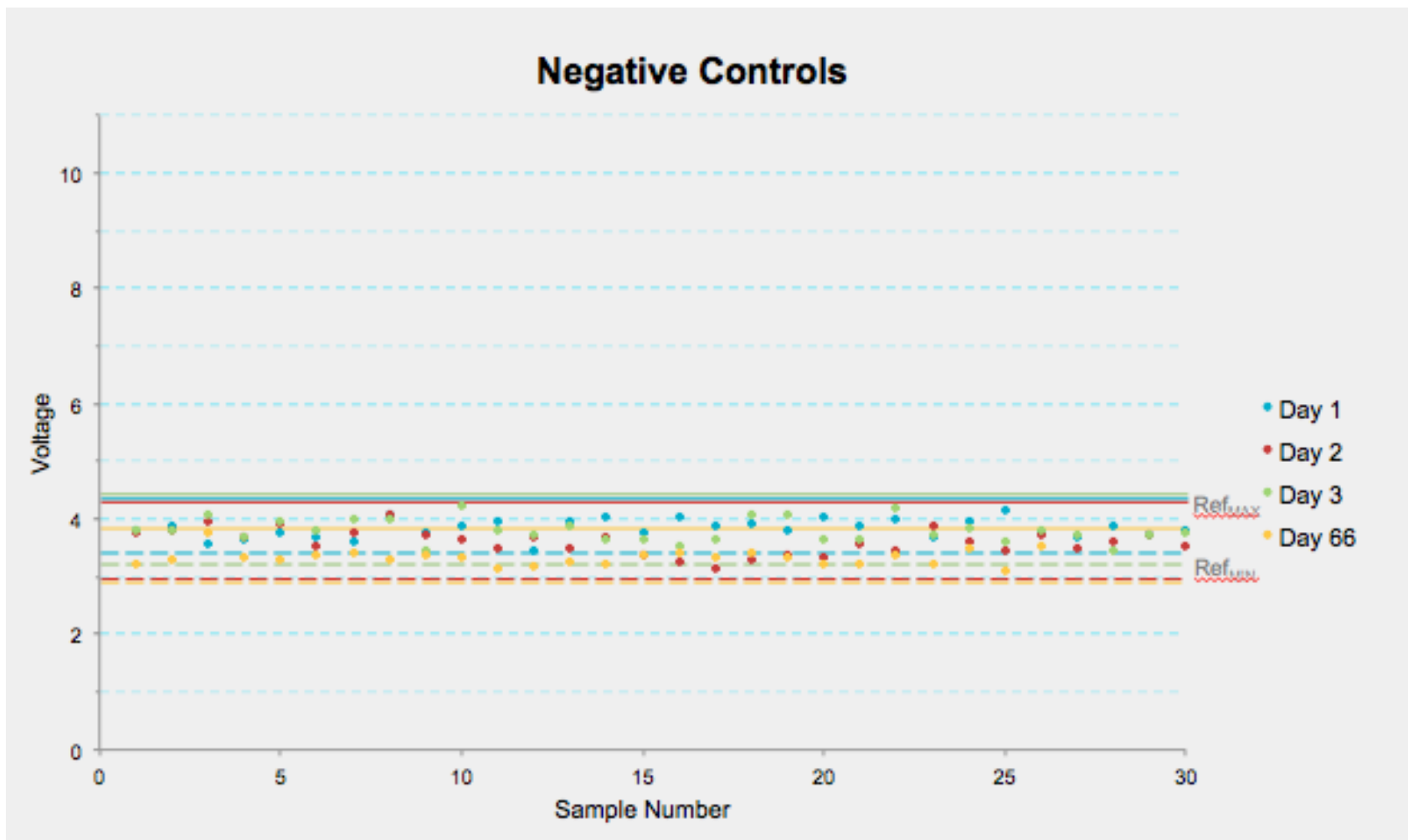

Case Study 1: HVLD^{MC} with Albumin Solution (1,2,3 and 66 days)

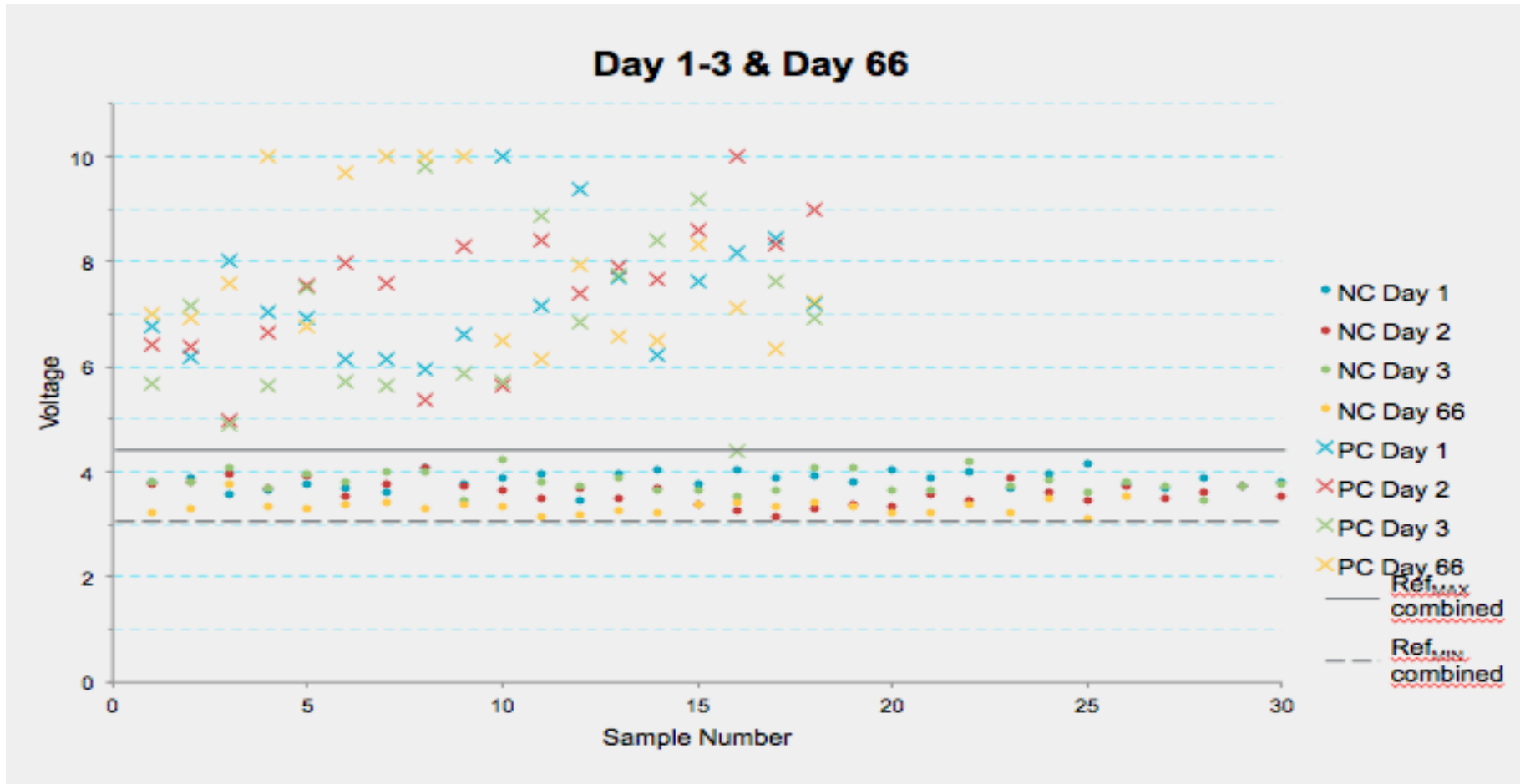

Case Study 2: Vacuum vs. HVLD^{mc} for PFS

- ✓ 1mL and 2.25 mL Syringe (Water and Albumin)
- ✓ Positive Controls: 5, 10 und 20 μm laser drilled holes, barrel and shoulder.
- ✓ 3 positive controls with water for each size
- ✓ 5 positive controls with Albumin for each size
- ✓ Albumin concentration of 17.5%
- ✓ Two test methods: Vacuum Decay and HVLD^{mc}

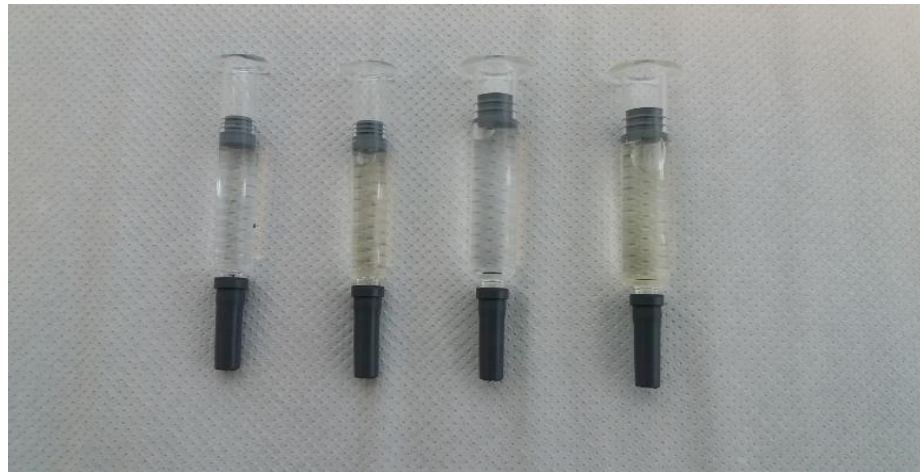

Vacuum Decay

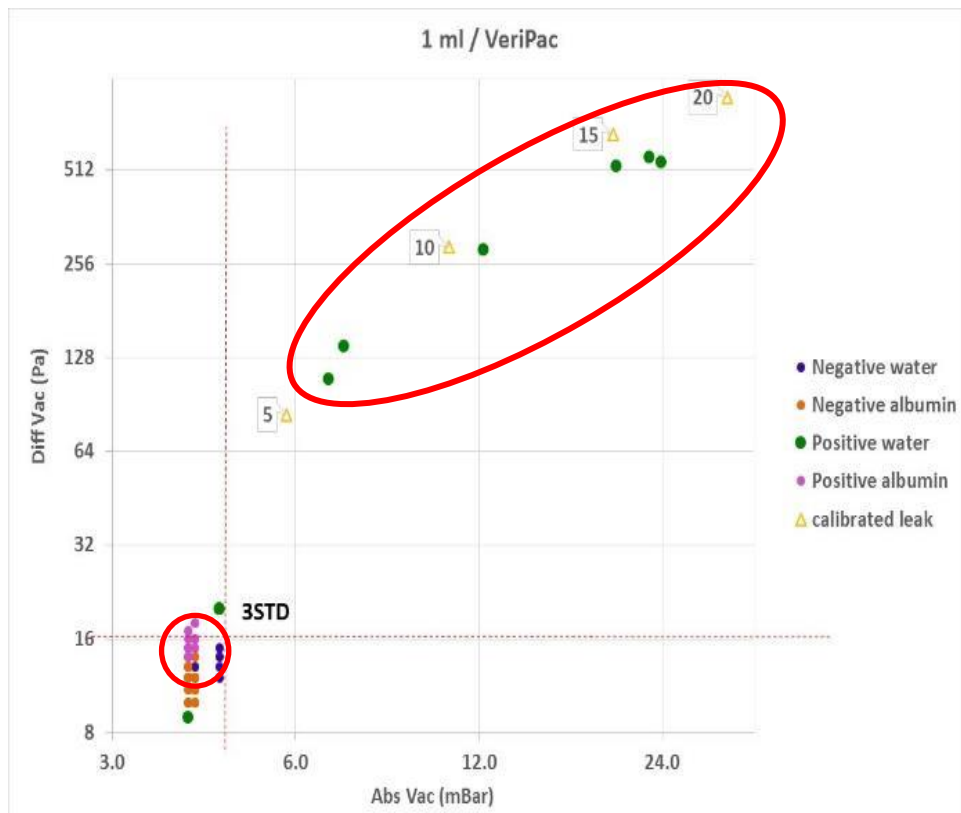

- Vacuum Decay @ <5.0mbar
- Albumin & Water Samples
- Laser Drilled Defects 5, 10, and 20 μ m.



HVLD^{mc}

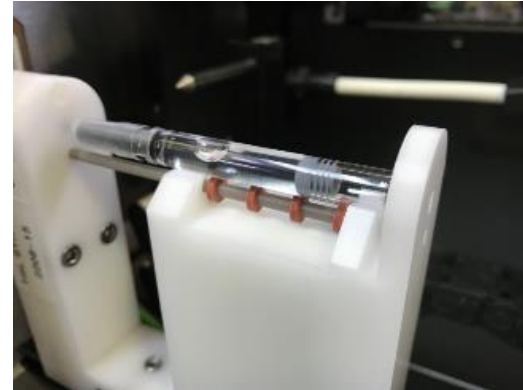
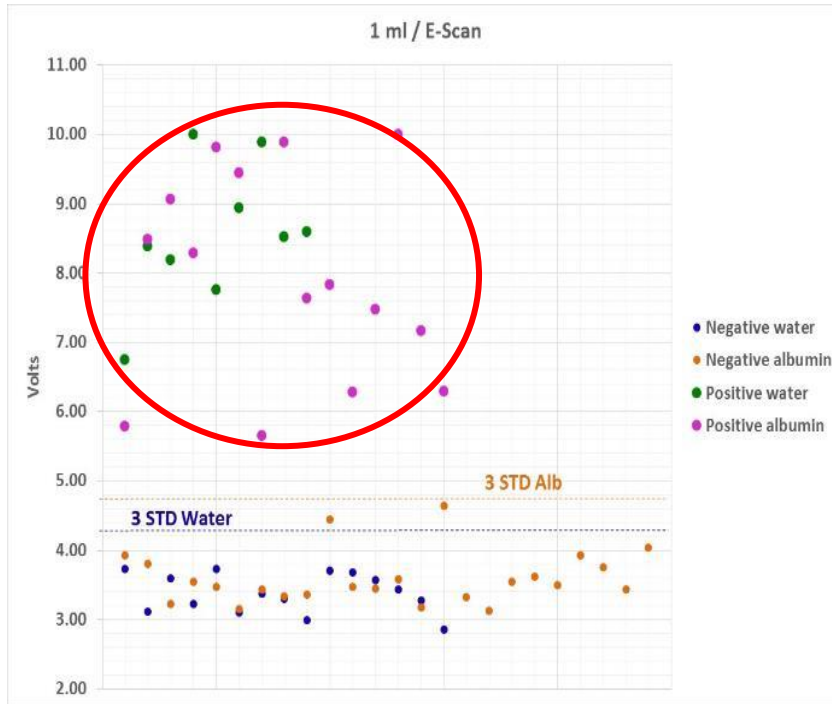

Conclusion

HVLD shows a clear advantage in detecting defects in parenteral packaging containing large molecule products.

Realistic Defects

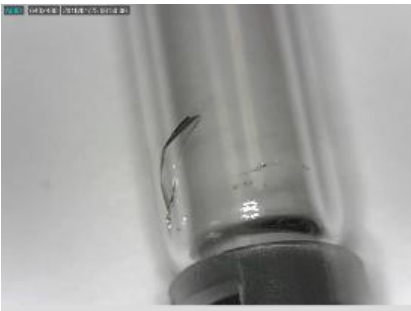

Naturally Occurring Defects

Sample	leak rate			Visual	Size um
	mbar·l/s	10 ⁻⁵ mbar·l/sec	sccm		
1	0.00095	95	0.05700	Large crack	2.67
2	0.0000021	0.21	0.00013	Medium crack	0.13
3	0.000014	1.4	0.00084	Medium crack	0.32
4	0	0	0.00000	Small Scratch	0.00
6	0.00067	67	0.04020	Large crack	2.24
7	0.015	1500	0.90000	Large crack	10.61
9	0.00000029	0.029	0.00002	Small crack	0.05
10	0.00029	29.0	0.01740	Large crack	1.47
11	0.074	7400	4.44000	Large crack	23.56
12	0.055	5500	3.30000	Large crack	20.31
16	0.0014	140	0.08400	Small crack	3.24
18	0	0	0.00000	Small Scratch	0.00
19	0	0	0.00000	Small Scratch	0.00
20	0.016	1600	0.96000	Large crack	10.95

Sample 2



Sample 6



Sample 3



Sample 16



Defect Detection

- ❖ Controlled crack produced.
- ❖ Certified flow measurement with Helium mass spec.
- ❖ Peak signal response is recorded.
- ❖ Voltage signal response with each rotation.

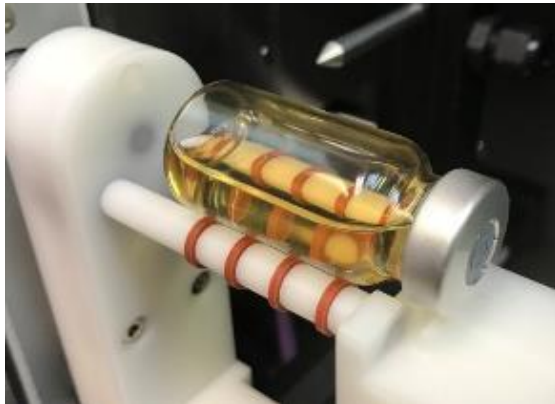

He Certified Leak Rate	
95.0	10 ⁻⁵ mbar·l/s
0.05700	sccm
2.67	~µm

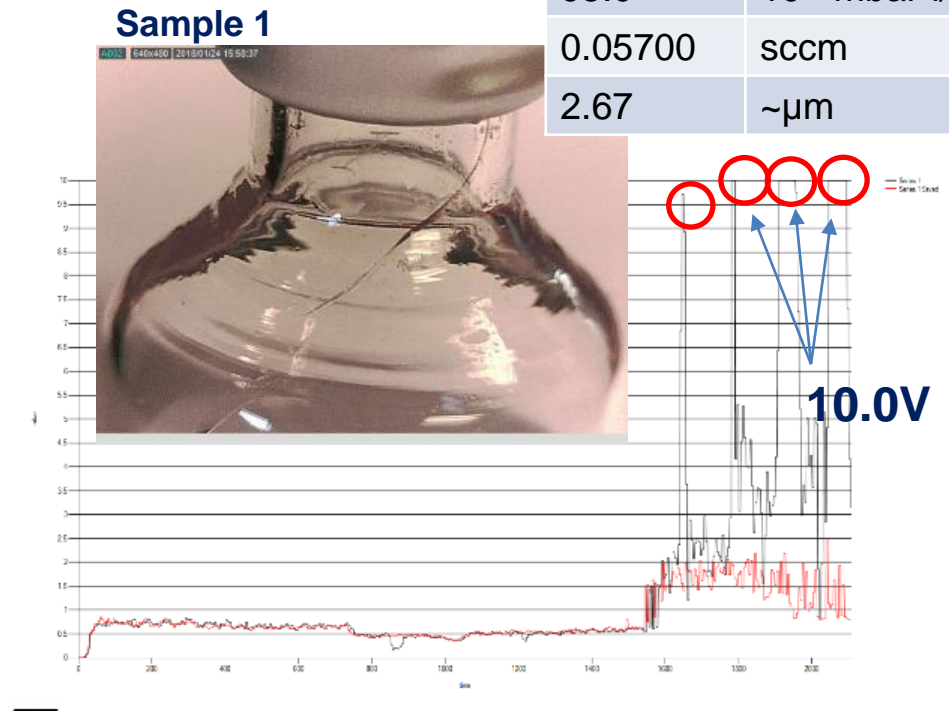

Traditional Target Leak Sizes

Sample 6



He Certified Leak Rate

67.0	10^{-5} mbar·l/s
0.04020	sccm
2.24	~ μ m

10.0V

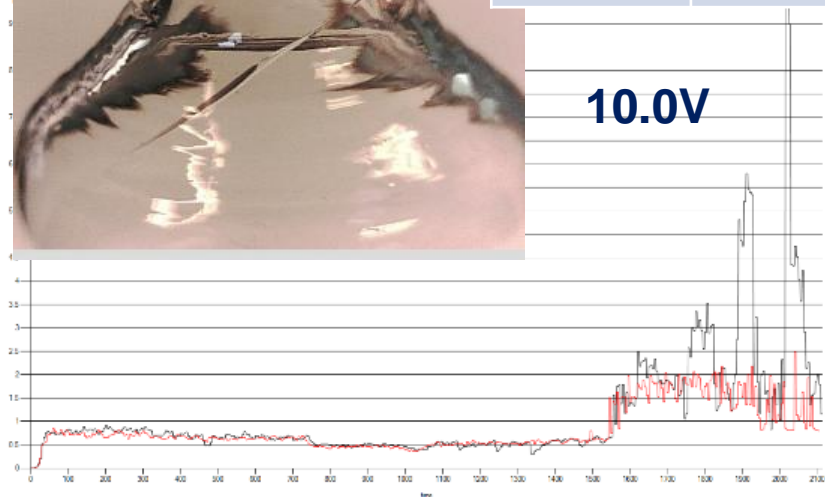

Sample 3



He Certified Leak Rate

29.0	10^{-5} mbar·l/s
0.01740	sccm
1.47	~ μ m

10.0V

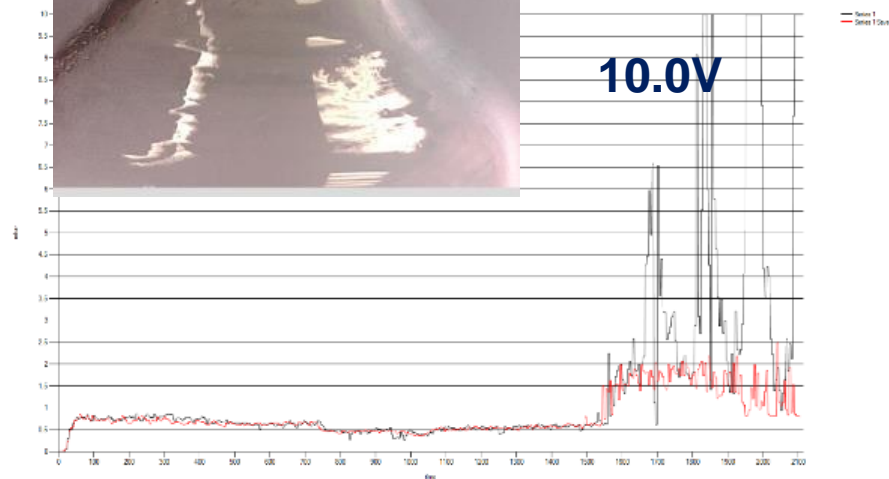

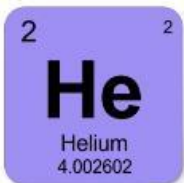

Leak Rates

Sample 2

He Certified Leak Rate

0.21	10 ⁻⁵ mbar·l/s
0.00013	sccm
0.13	~μm



Sample 3

He Certified Leak Rate

1.40	10 ⁻⁵ mbar·l/s
0.00084	sccm
0.32	~μm

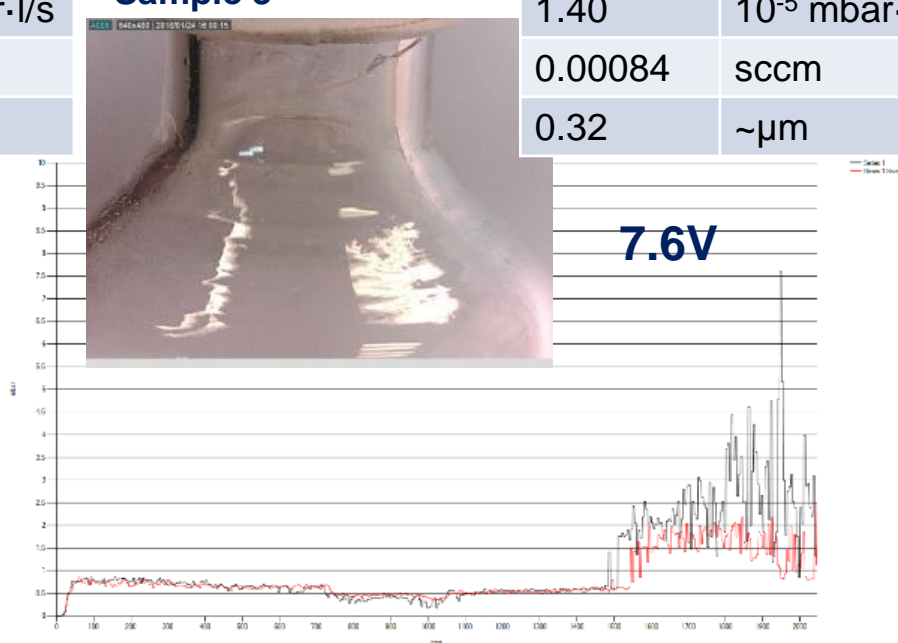

Summary

- **Vacuum decay is a sensitive and reliable test method for gas applications**
- **Reliability and capability of Vacuum decay is adversely affected by large molecule products such as Albumin, producing a low to zero detection capability for protein base solutions**
- **MicroCurrent High Voltage Leak Detection (HVLD^{mc}) is capable of detecting micro cracks down to the MALL, including for low conductivity liquids**
- **HVLD^{mc} is not time critical (time zero vs. day 66).**
- **MicroCurrent HVLD^{mc} generally effective for wide range of product conductivities.**
- **Naturally occurring defects below the 1µm level can be readily detected using HVLD^{mc}**
- **Nonvisible cracks below the crimping are detectable**



Thank you!

Tatiana Simental
t.simental@ccit.com
CH +41 21 805 0020
USA +1 914.337.2005
www.ccit.com
www.ptiusa.com