



CONNECTING  
PEOPLE  
SCIENCE AND  
REGULATION®



# Container Closure Integrity: Regulations, Test Methods, Application - Deterministic Test Methods



PDA  
TRAINING

# Deterministic Leak Test Methods

- ❖ **Tracer gas detection (vacuum mode)**
- ❖ **Vacuum and pressure decay**
- ❖ **Mass extraction**
- ❖ **Laser-based gas headspace analysis**
- ❖ **Electrical conductivity and capacitance (High voltage leak detection, HVLD)**
- ❖ **Optical Emission Spectroscopy (OES)**

# Tracer Gas Detection (Vacuum Mode)

- ❑ **Detection:** Tracer gas leakage rate in mass flow units
- ❑ **Technology**
  - Quantitative measurement of tracer gas leak rate from a gas-charged test sample into a vacuum chamber.
  - Output analyzed by spectrometric means.
  - Leak rate calculated by normalizing results by the concentration of tracer gas in the test sample.
  - Calibrated leak standards used to verify method accuracy.
- ❑ **Test**
  - Flood helium tracer gas (or perhaps hydrogen) into test sample. Use restraint mechanism for flexible package or package with non-fixed components as required.
  - Place test sample in vacuum chamber connected to spectroscopic analyzer specific for tracer gas (for Helium: Mass spec analysis).
  - At test start, chamber is evacuated, and tracer gas is drawn into analyzer; gas mass flow rate is reported. Normalize findings based on test sample tracer gas concentration.

# Tracer Gas Detection (Vacuum Mode)

## ☐ Sensitivity & Quantitative

- Mass spectrometer as detector

## ☐ Selectivity



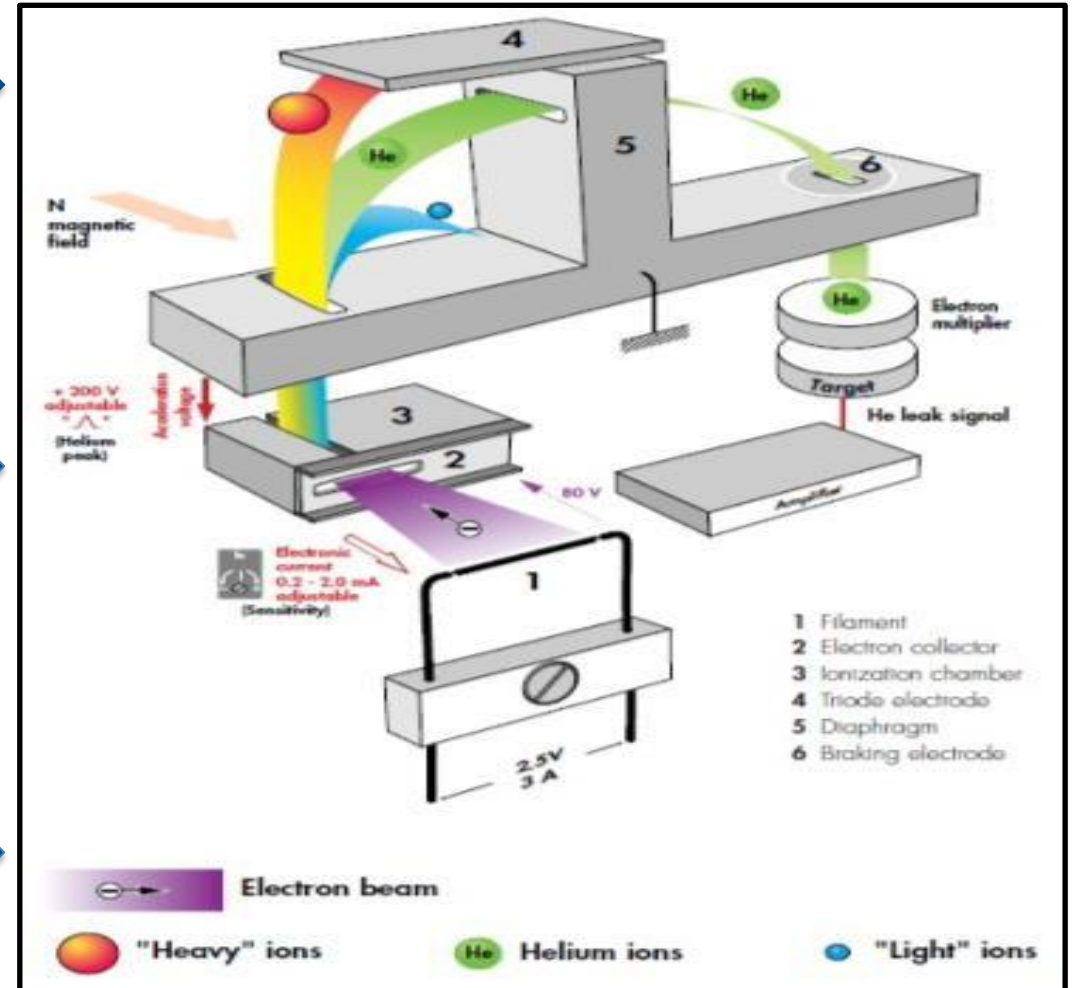

- Low atmospheric interference: Helium in the atmosphere (~5 ppm)
- Do need to minimize lab ambient helium and permeation

## ☐ Flows through cracks ~2.7x faster than air

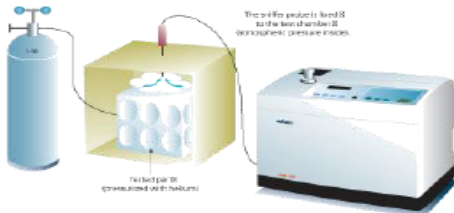

# Tracer Gas Detection (Vacuum Mode)

The HLD can be used in different way depending on your objective:

LOCATION OF THE LEAK - maintenance application - quality control		GLOBAL TEST - industrial application - quality control	
<p><b>SPRAYING TEST</b> (vacuum method)</p> <ul style="list-style-type: none"> <li>- the system or the UUT can be placed under vacuum.</li> <li>- you need to detect very small leaks.</li> </ul> 	<p><b>SNIFFING TEST</b> (test is performed at atmospheric pressure)</p> <ul style="list-style-type: none"> <li>- the system or the UUT : &gt; cannot be placed under vacuum &gt; can be charged with helium</li> <li>- the sensitivity is not a major issue</li> </ul> 	<p><b>SNIFFING TEST WITH ACCUMULATION</b> (test is performed at atmospheric pressure)</p> <ul style="list-style-type: none"> <li>- the system or the UUT : &gt; cannot be placed under vacuum &gt; can be charged with helium</li> <li>- the sensitivity is not a major issue</li> </ul> 	<p><b>GLOBAL HARD VACUUM TEST</b> (Vacuum Method)</p> <ul style="list-style-type: none"> <li>- the system or the UUT : &gt; can be placed under vacuum &gt; can be charged with helium</li> <li>- you need to detect very small leaks.</li> </ul> 

Slide courtesy of Pfeiffer Vacuum

# Tracer Gas Detection (Vacuum Mode)

## Requirements

### Package

- Nonporous, rigid; all types of vials, bottles, syringes
- Flexible or non-fixed components may employ optional restraint mechanism; blisters, pouches, bags
- Small volume to large volume
- Ability to tolerate high test vacuum
- Limited tracer gas permeability (plastics with limited helium permeability, glass, metal)

### Product: Tracer gas only must be present at leak site

Best performed on empty test sample. Product drawn into analyzer may cause instrument damage.

Generally performed off-line in R&D for inherent CCI verification.

Can be employed in manufacturing for line set-up

# Tracer Gas Detection (Vacuum Mode)

## ❑ Limitations

- Permeation of tracer gas through package can be mistaken for leakage.
- Tracer gas escape through large leaks before test performed can lead to false negatives.
- May be necessary to utilize headspace analyzer to adjust leak rate results.
- Tracer gas background in testing environment can influence test results.
- Proper fixturing is important to capture leakage site of interest.
- Requires seconds to minutes per test sample.

## ❑ Merits

- Highly sensitive and quantitative method.
- Even long, tortuous leaks can be detected; Blocked leak paths prevent detection.
- Detection range: 0.01  $\mu\text{m}$  to mm may be possible.
- Non-destructive, IF tracer gas introduction into test sample poses no threat to product sterility/quality.
- Requires seconds to minutes per test sample.

# Vacuum Decay Test

- ❑ **Detection:** Gas or volatilized product leakage rate in pressure rise units
  
- ❑ **Technology**
  - Quantitative measure of pressure rise (vacuum decay) typically within an evacuated test chamber housing a test sample, resulting from test sample headspace leakage or liquid product volatilization
  - Output compared to that of leak rate standards, plus pre-determined limits using no-leak and with-leak controls

Reference ASTM F2338



# Vacuum Decay Test

## Vacuum – Pressure decay

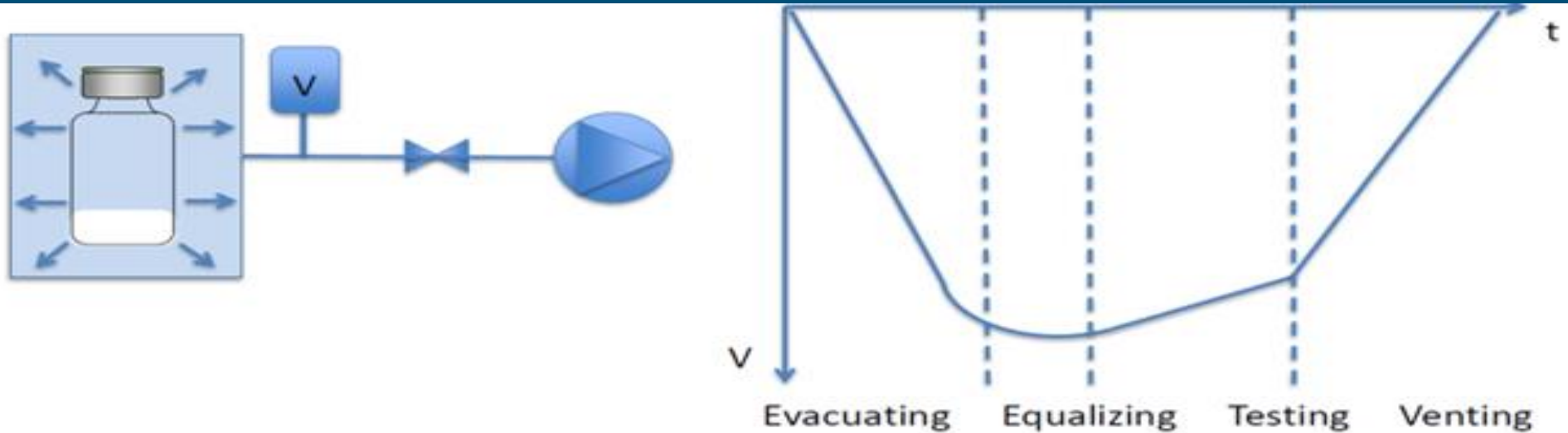

Standard vacuum decay



vacuum levels between 300-900 mbar

4 Phases

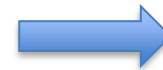

Complete testing cycle of approx.6 sec. for 10µm for in-applications or 5µm with single station

Slide courtesy of Wilco

# Vacuum Decay Test

## Vacuum – Pressure decay

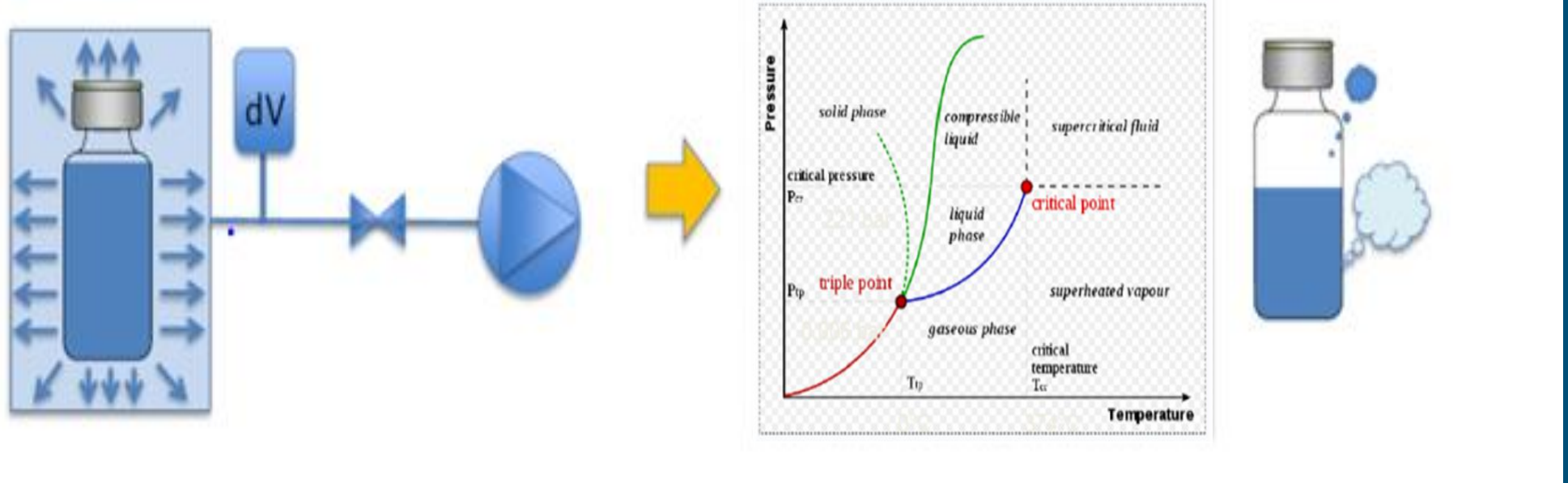

Deep vacuum decay



absolute testing pressure below triple point of water

4 Phases

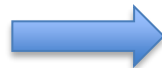

capabilities of detecting leaks down to 8µm for in-line application

Slide courtesy of Wilco

# Vacuum Decay Test

## Requirements

- Performed off-line in R&D and stability for CCI verification
- Performed on-line for routine manufacturing testing
- Formulations
  - For gas at leak site, sufficient headspace volume required
  - For liquid at leak site, solution formulations capable of volatilization at test pressure required
- Packages
  - All types of vials, bottles, ampoules, syringes, blisters, pouches, bags, etc.
  - Small volume to large volume
  - Plastics, glass, metal
  - Rigid to flexible (with restraint mechanism)
  - Porous if mechanism for blocking porous structure employed

# Vacuum Decay Test

## Limitations

- ❖ Solidified product or debris in leak path may block leak detection
- ❖ Test fixture or restraint mechanism at test sample site of contact may block leak path
- ❖ Volatiles or liquids drawn into test system can cause damage
- ❖ Requires several seconds to minutes per test sample

# Vacuum Decay Test

## Merits

- ❖ Nondestructive
- ❖ Detection range: 2-5  $\mu\text{m}$  to mm may be possible
  - ❑ Detection Limits Varies with:
    - Leak size, type, length, blockage
    - Package internal volume, flexibility, outgassing
    - Test system volume, test system outgassing, sensitivity of pressure transducers
    - Test time, target vacuum
- ❖ Requires several seconds to minutes per test sample
- ❖ May be performed on-line in manufacturing (speed could impact sensitivity)

# Vacuum Decay Test

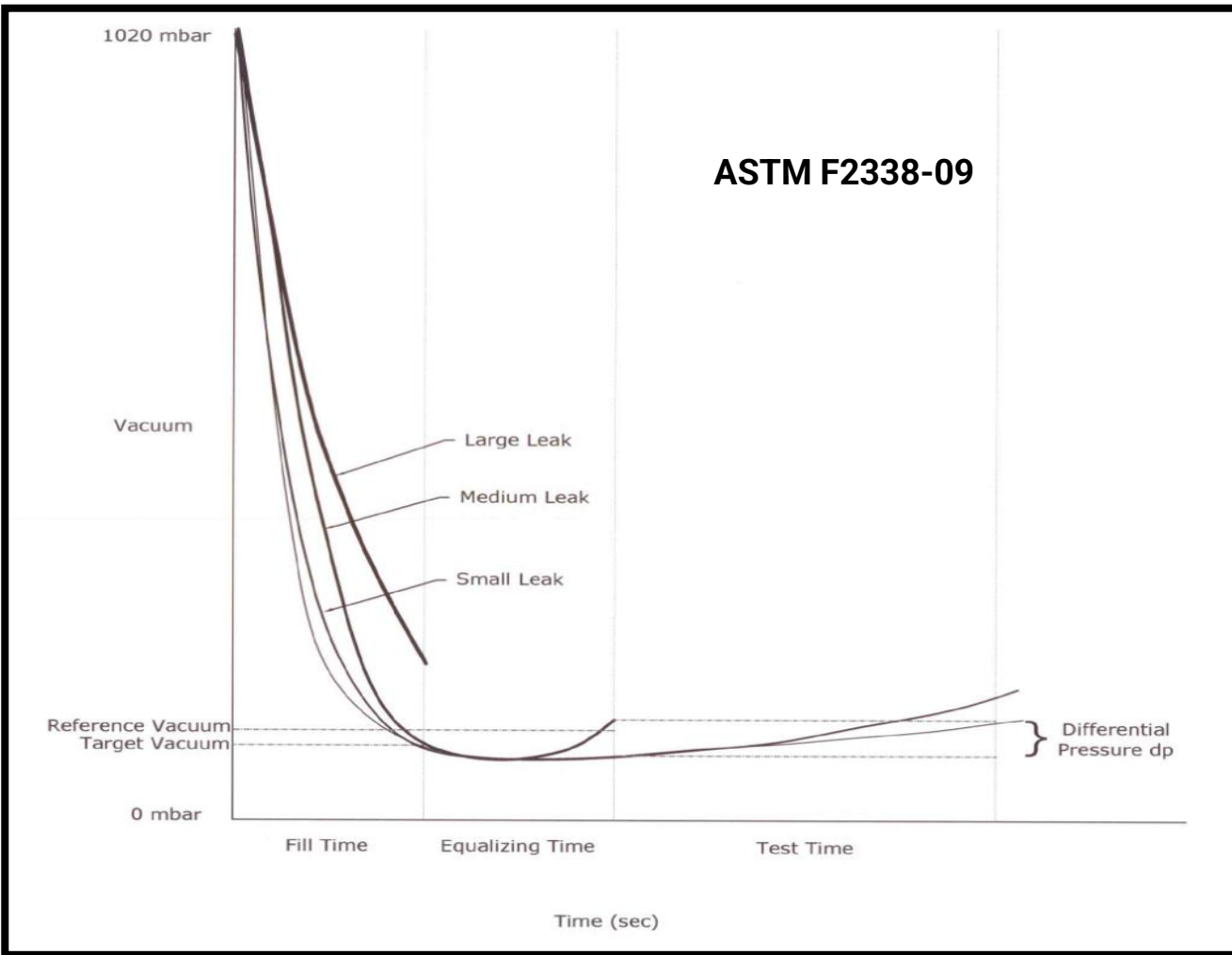

## Test Method Sequence of Events

1a. Vacuum drawn during FILL Time  
1000 Torr Transducer (mbar)

1b. Vacuum source is shut OFF

2. Pressure rise monitored during  
EQUALIZATION and TEST  
Times  
1000 Torr Transducer (mbar)

3. Pressure rise monitored during  
TEST Time  
10 Torr Transducer (Pa)

# Pressure Decay Test

- ❑ **Detection:** Gas leakage rate in pressure decay units
- ❑ **Technology**
  - Quantitative measure of pressure decay within a pressurized test sample.
  - Output compared to that of leak rate standards, plus pre-determined limits using no-leak and with-leak controls.

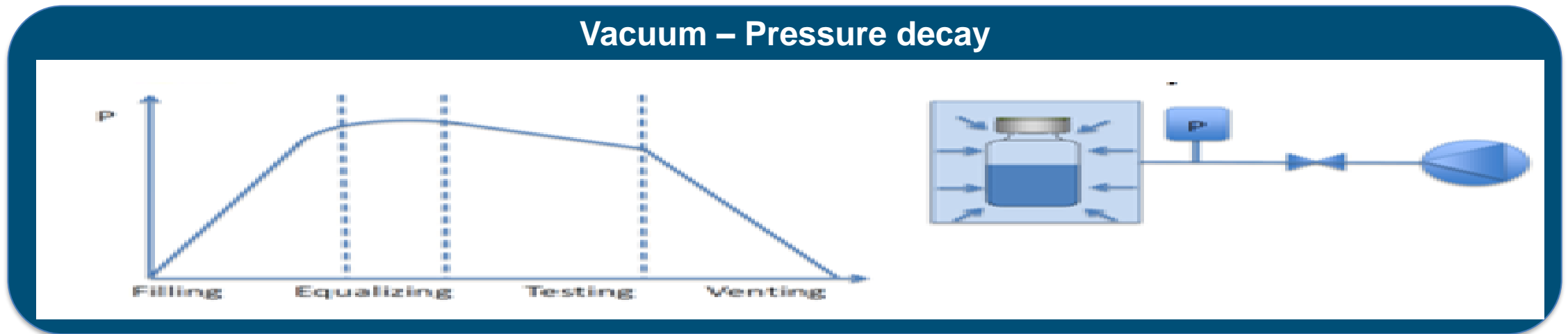

Pressure decay ➔ Pressure levels between 300 – 900mbar

4 Phases ➔ Complete testing cycle of approx. 6 seconds for 10 µm

**Reference: ASTM F2095 (for flexible packages)**

# Pressure Decay Test

## Requirements

- ❖ Formulations
  - Gas only must be present at leak site
  - Product must not obstruct leak path
- ❖ Packages
  - All types of vials, bottles, syringes, pouches, bags, etc.
  - Small volume to large volume to bulk containers
  - Plastics, glass, metal
  - Rigid to flexible to non-fixed components (restraint mechanism may be required)
  - Manufacturing equipment, incl. tanks, aseptic isolation systems
- ❖ Can be performed off-line in R&D for inherent CCI verification
- ❖ Can be performed on packages on-line in manufacturing (e.g., empty bottle test)
- ❖ Can be performed in manufacturing to check equipment/line integrity

## Limitations

- ❖ Solidified or liquid product or debris in leak path may block leak detection.
- ❖ Test requires several seconds (small volume test samples) to days (largest volume samples), depending on test sample volume and leak limit of detection required.



# Pressure Decay Test

## Merits

- ❖ Nondestructive: If gas introduction into test sample poses no threat to product sterility/quality
- ❖ Detection range: 2-5  $\mu\text{m}$  to mm may be possible
- ❖ Detection limit varies with:
  - Leak size, type, length, material of construction, blockage
  - Package internal volume, flexibility
  - Test time; target pressure; gas temperature and humidity control; pressure sensor sensitivity
- ❖ Can be performed on packages on-line in manufacturing (e.g., empty bottle test)
- ❖ Test requires several seconds (small volume test samples) to days (largest volume samples), depending on test sample volume and leak limit of detection required

# Pressure Decay Test / Vacuum Decay Test Vacuum-Pressure Decay



Pressure decay	Vacuum decay	Deep vacuum decay
8-10µm	8-10µm	8-10µm
8-10µm	For freeze dried Products 8-10µm	5-8µm
Headspace volume required	Headspace volume required	Headspace volume required

- ❖ Trapped air effect
- ❖ Clogging effect due to proteinaceous solutions as well as sucrose or salts
- ❖ Positive controls like laser drilled holes or capillaries with use of real product

# Mass Extraction (aka Mass Flow Test)

- ❑ **Detection:** Gas or volatilized product leakage rate in mass flow rate units
- ❑ **Technology**
  - Quantitative measure of gas mass flow rate within an evacuated test chamber housing a test sample, resulting from test sample headspace leakage or liquid product volatilization.
  - Output compared to that of leak rate standards, plus pre-determined limits using no-leak and with-leak controls. Multiple vacuum stages can be used to check for larger or smaller leaks.

## ❑ ASTM F3287

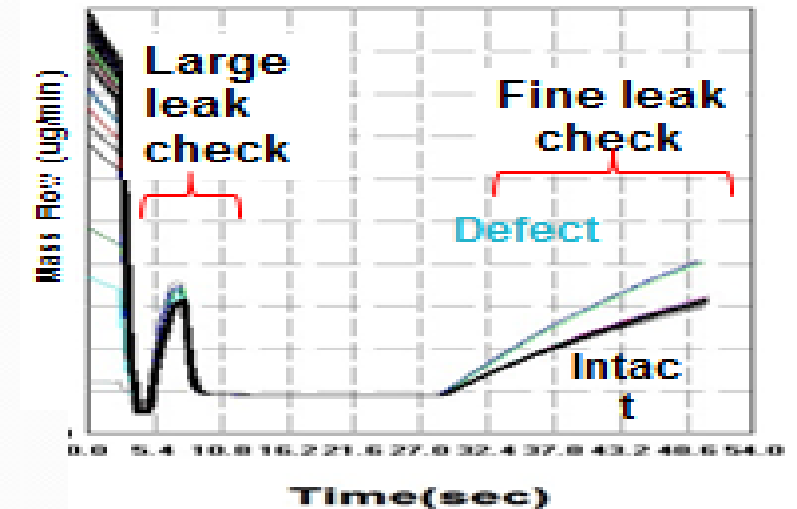
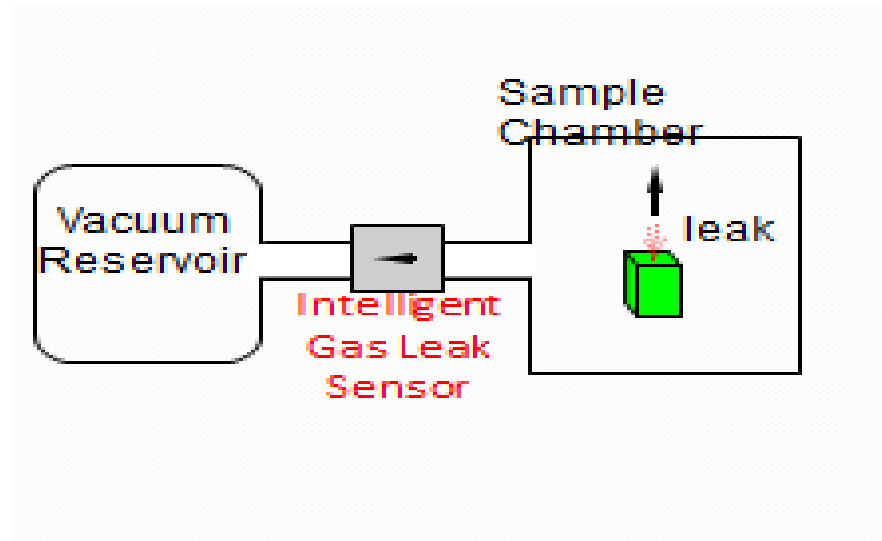

# Mass Extraction

## Method of operation-Mass extraction

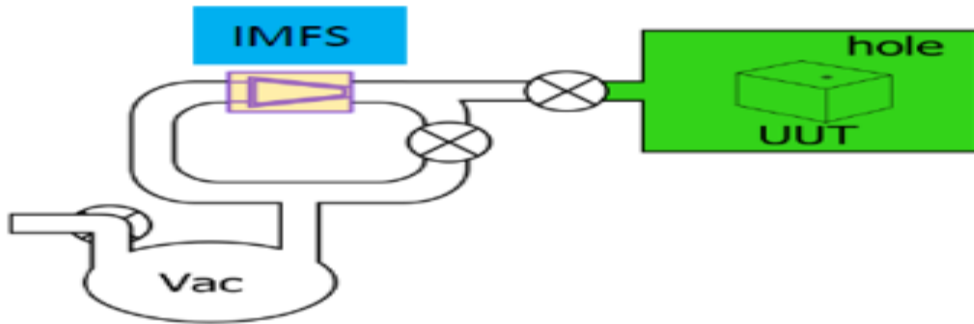

**1 Standby** - Vacuum Reservoir:  $P_0$   
- IGLS: no flow

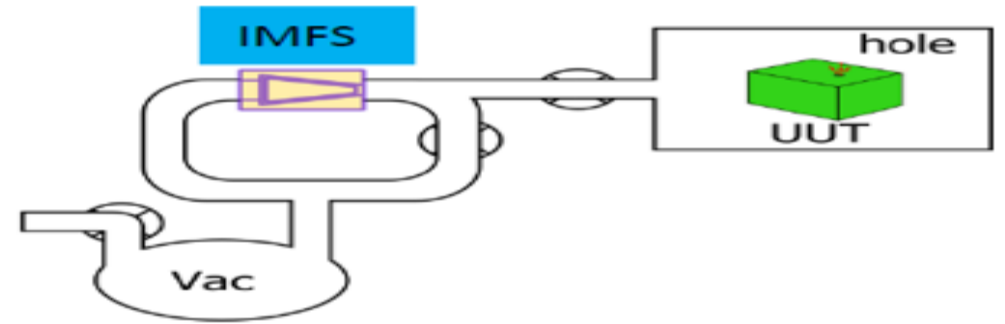

**2 Evacuate** - All branches:  $P_0$   
- IGLS : No flow  
- UUT : Leaks

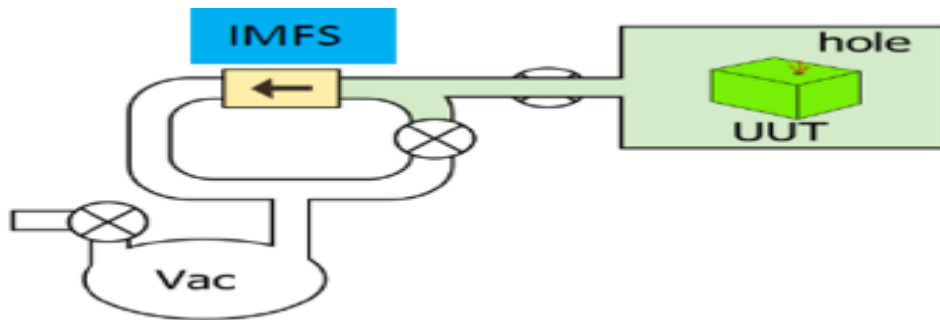

**3 Stabilize** - Leak : Increases  $P_{\text{chamber}}$   
- IGLS : Begins flow

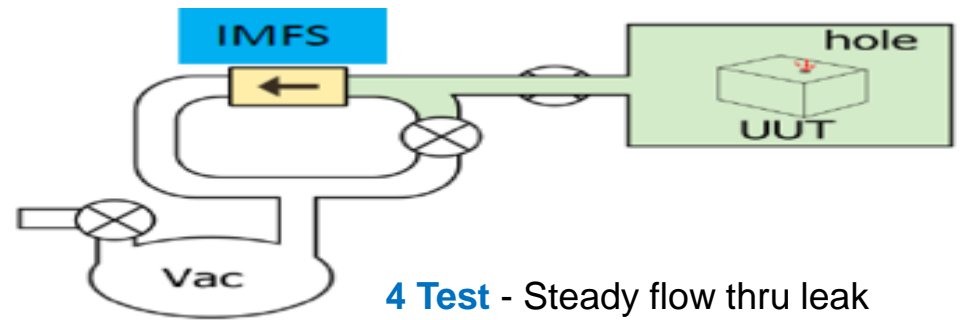

**4 Test** - Steady flow thru leak  
- IGLS : Measures flow thru leak

Slide courtesy of Pfeiffer Vacuum

# Mass Extraction

Example : Flow measurement – Signature Test  
(vial with and without 2 $\mu$  leak)

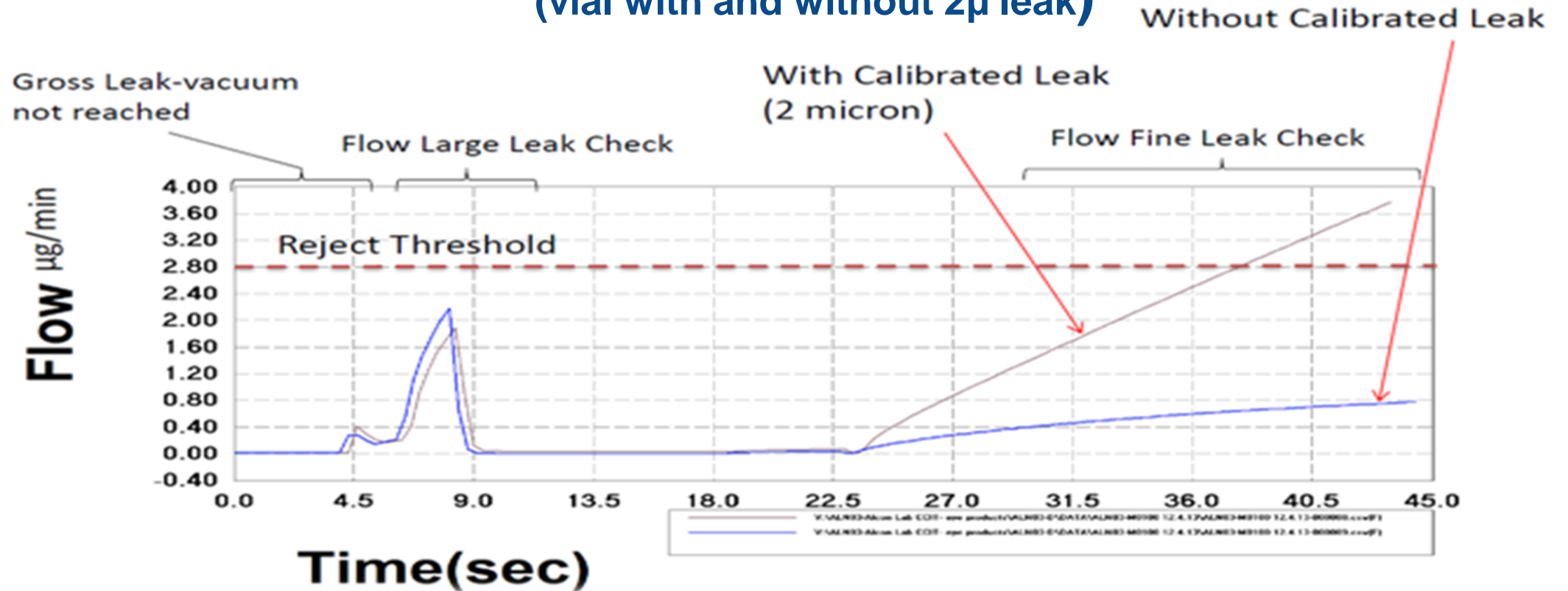

Note : The smaller defect size mass extraction is set to detect (Limit Of Detection)-the lower is the customer risk.

Slide courtesy of Pfeiffer Vacuum

# Mass Extraction Robustness Test

Robustness study is an indicator for long term reliability. Study included multiple operators, testing days, and two stand-alone instruments were used to understand variations of the method. A total of 12 different combinations including two extreme vial sizes (2 and 50 mL) were incorporated into the design and 6 vials per combination were tested. For the syringe study, a total of 8 combinations were incorporated into the design and 90 syringes per combination were tested.

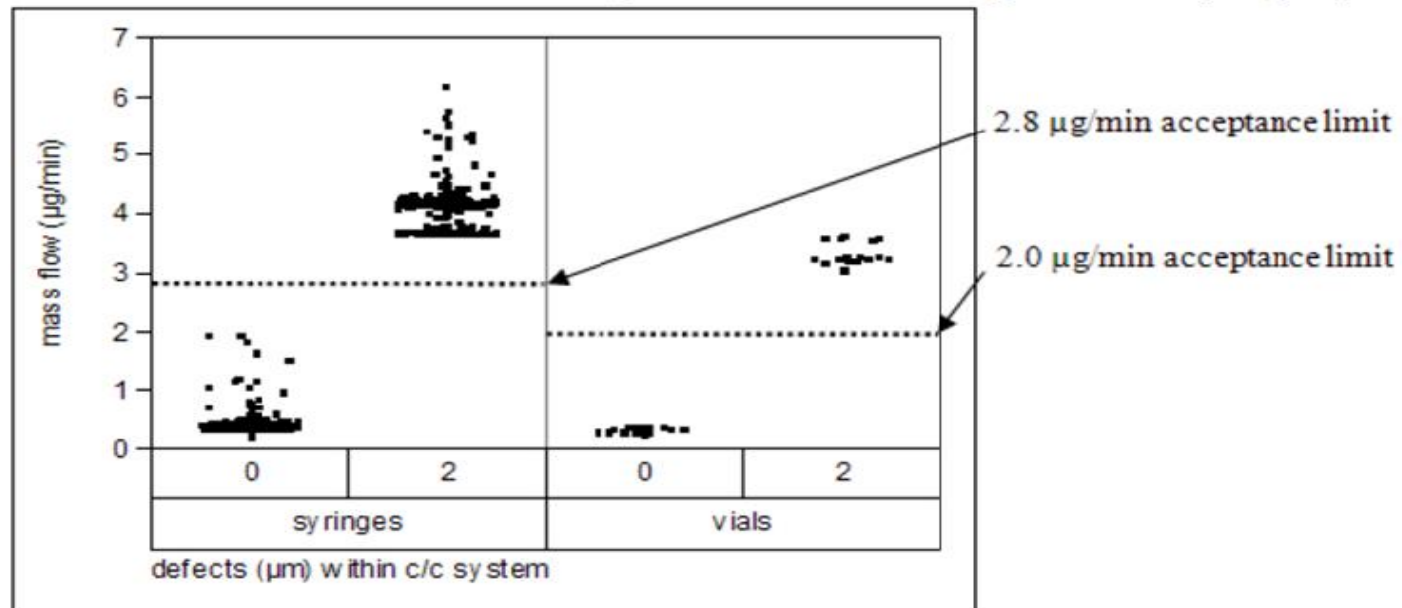

**Reference:** *PDA J Pharm Sci and Tech* 2012, 66 403-419

**Mass Extraction Container Closure Integrity Physical Testing Method Development for Parenteral Container Closure Systems;** by: SEUNG-YIL YOON, HEMI SAGI, CRAIG GOLDHAMMER, and LEI LI

Slide courtesy of Pfeiffer Vacuum

# Mass Extraction

## Requirements for Usage

### Formulations

- ❖ Gas headspace of sufficient volume at leak site required, OR
- ❖ Liquid (capable of volatilization) must be present at leak site

### Packages

- ❖ All types of vials, bottles, ampoules, syringes, pouches, bags, etc.
- ❖ Small volume to large volume
- ❖ Plastics, glass
- ❖ Rigid to flexible (with restraint mechanism)
- ❖ Porous if mechanism for blocking porous structure employed

## Limitations

- ❖ Solidified product or debris in leak path may block leak detection
- ❖ Test fixture or restraint mechanism at test sample site of contact may block leak path
- ❖ Volatiles or liquids drawn into test system can cause damage
- ❖ Generally performed off-line
- ❖ Used in all product life cycle phases
- ❖ Requires several seconds to minutes per test sample

# Mass Extraction

## Merits

- ❑ Nondestructive
- ❑ Simple and fast (1-2 min/sample)
- ❑ Flexible
  - Containers of various sizes and geometries
  - Applicable to injection devices
- ❑ Sensitive: 1  $\mu\text{m}$  capable, typically 5-10  $\mu\text{m}$ 
  - Detection limit varies with:
    - Leak size, type, length, blockage
    - Package flexibility, size, outgassing
    - Test system volume, test system outgassing, sensitivity of pressure transducers and mass flow meter
    - Test time, target vacuum





# Laser Based Gas Headspace Analysis

**Detection:** Gas headspace content

## Technology:

- ❑ Quantitative measure by laser-based analysis of oxygen concentration, water vapor concentration, and/or low absolute pressure.
- ❑ Output compared to that of standard gas mixtures.
- ❑ Absorption is proportional to pressure.
- ❑ Amplitude is proportional to concentration.
- ❑ To determine leak rate, change in headspace is measured over time.

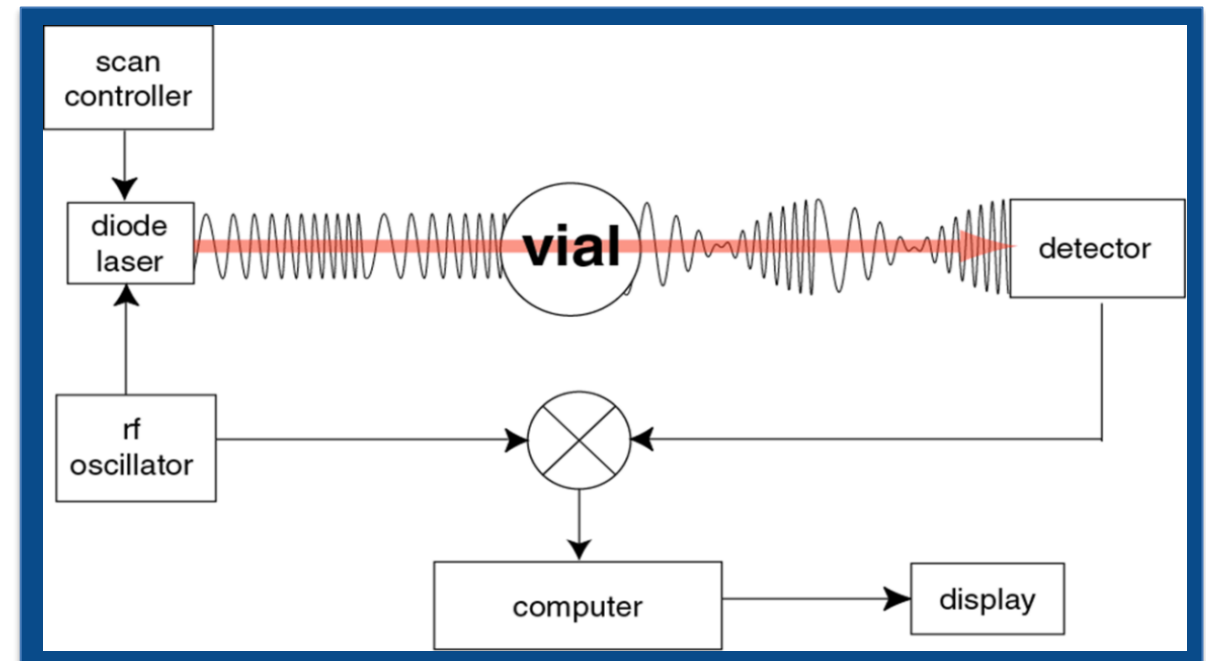

# Laser Based Gas Headspace Analysis

## Requirements

- Package: Non-porous, transparent or translucent, amber or colorless
- Product: Headspace gas volume, path length and content must be compatible with instrument capability



### What gases can be measured?

- ❖ Headspace oxygen
- ❖ Headspace carbon dioxide
- ❖ Headspace moisture (Water vapor)
- ❖ Headspace total pressure levels



Slide courtesy of Lighthouse

# Laser Based Gas Headspace Analysis



## Modified Atmosphere

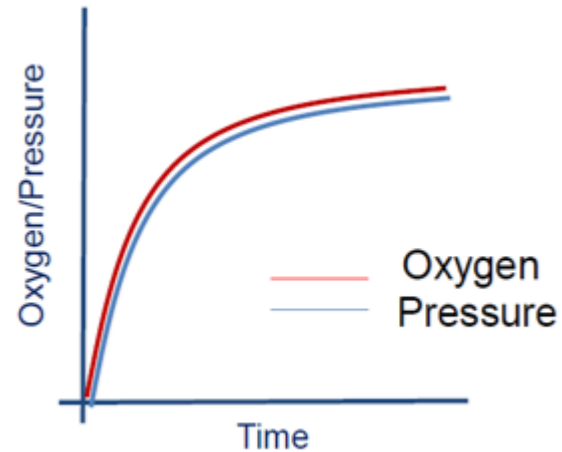

### Product

Stoppered under a modified atmosphere

Lyophilized product:

Partial vacuum with nitrogen or full vacuum

Oxygen sensitive liquids:

Purged with nitrogen

### Storage condition

Ambient air

### Leak Indicating Measurement

Increase in oxygen level and / or increase  
In pressure.

### Application

Laboratory instruments or fully automated  
inspection

Slide courtesy of Lighthouse

# Laser Based Gas Headspace Analysis

Chamber that can be purged or evacuated

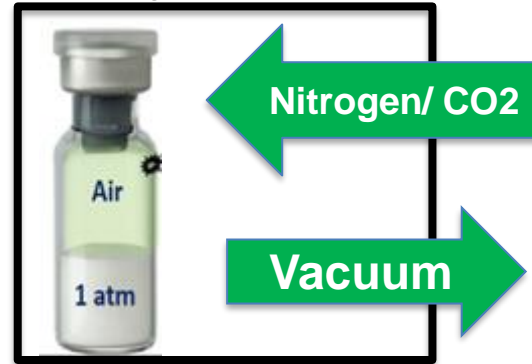

## Non-Modified Atmosphere

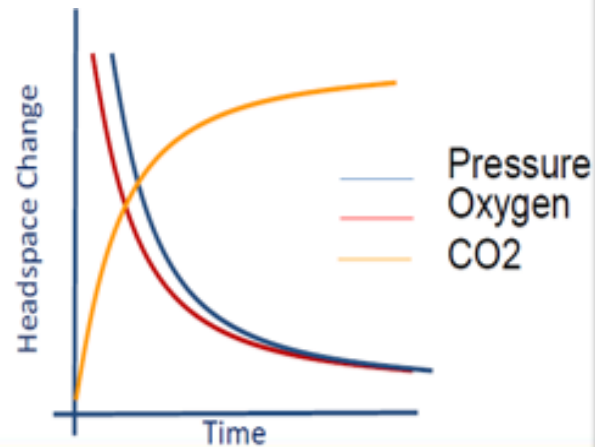

### Product

Stoppered under a non-modified atmosphere

Headspace is air at 1atm

Typical of many liquids

### Storage conditions

Must put container in a chamber to drive a headspace change (similar to Blue Dye Testing but HSA is more sensitive and doesn't involve dye). After a pre-determined conditioning time then remove and test in a headspace analyser.

### Leak Indicating Measurement

Decrease in oxygen level/increase in CO<sub>2</sub>/

Decrease in pressure level.

### Application

Laboratory instruments

Slide courtesy of Lighthouse

# Laser Based Gas Headspace Analysis

## Limitations

- Vendors vary in capability of gases and package materials/designs that can be tested
- Faster test speed can raise standard deviation of findings
- Test sample outer surface moisture may hamper test performance
- Test sample temperature influences gas pressure and moisture readings
- Not a direct measure of leakage
- Leakage can be calculated by analysis of sample headspace change as a function of time
- Change of headspace due to permeation should be considered

# Laser Based Gas Headspace Analysis

## Merits

- ❑ Nondestructive
  - Sensitive:  $<0.1\mu\text{m}$  to largest leaks are possible
  - Can be performed on- or off-line
  - Can provide just-in-time headspace content analysis
  - Used in all product life cycle phases
  - Extremely rapid test ( $<1\text{s}$  to a few seconds per test sample)
    - Longer time required for increased sensitivity
- ❑ Multiple formulation types; liquids, lyophilized or dry powder, API, etc.
- ❑ Multiple packages; vials, bottles, ampoules, syringes, small to large volume, plastic, glass, transparent, translucent, amber, colorless

# Electrical Conductivity & Capacitance Test aka High Voltage Leak Detection (HVLD)

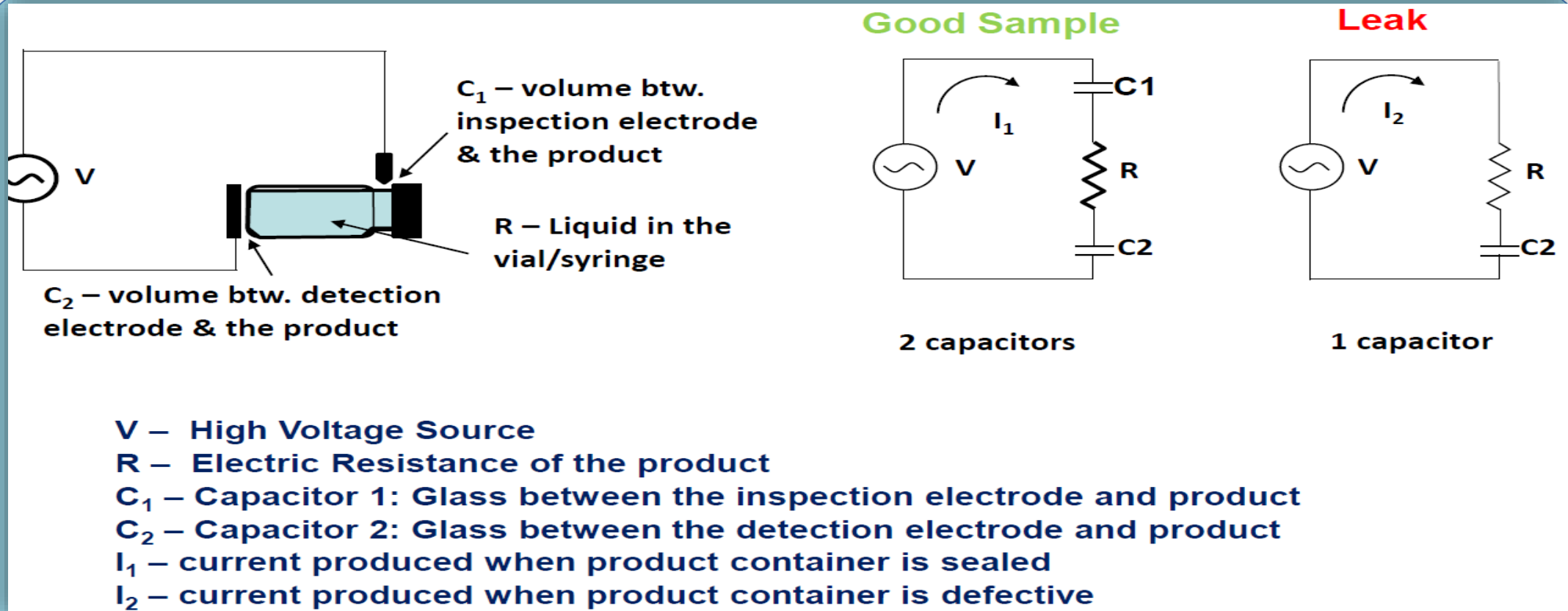

Slide courtesy of PTI

# High Voltage Leak Detection (HVLD)

- ❖ **Detection:** Liquid presence in or near leak path
- ❖ **Technology:**
  - Quantitative electrical conductance and capacity measurement
  - Measured current output judged against pre-set Pass/Fail limit

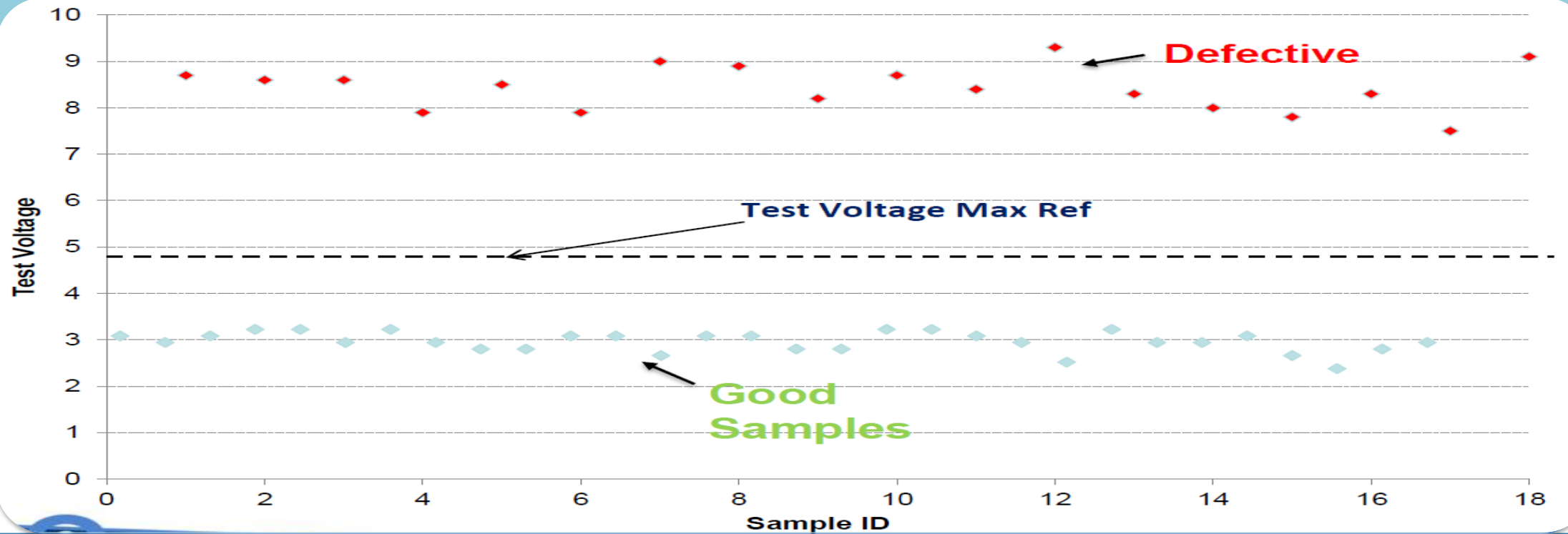

Graph courtesy of PTI



# High Voltage Leak Detection (HVLD)

## Limitations

- ❖ Sample is exposed to hi-frequency, hi-voltage, low-amperage (AC) current via an electrode that passes the test sample.
  - Electrical current frequency is a vendor-specific proprietary parameter
  - Electrodes differ in design and material.
  - Electrodes either contact or pass near the test sample surface
- ❖ Potential for product degradation, must assess product stability
- ❖ Liquid must be presence at leak site
- ❖ Product must be liquid or gel
- ❖ Product must be more electrically conductive than package.
- ❖ Product must be nonflammable

# High Voltage Leak Detection (HVLD)

## Merits

- ❑ Non-destructive (reports of product degradation from ozone generation in headspace during analysis, product stability should be assessed)
- ❑ Sensitive: 2 – 5  $\mu\text{m}$  size leaks (possibly much smaller). Varies with below parameters
  - Leak size, length, presence of product (liquid to solid) near or in leak
  - Test scan speed
  - Probe design and material of construction, proximity of probe to leak/liquid
  - Ground design, material of construction, position relative to the test sample
  - Current voltage/amperage/frequency setting
  - Ground sensitivity setting
  - Product vs. package conductivity

# High Voltage Leak Detection (HVLD)

## Merits

- Whole package surfaces or single point inspection possible
- Probe types include carbon brushes, metal probes, metallic beaded strands
- Can be performed on- or off-line
- Used in all product life cycle phases
- Extremely rapid test (<1s to a few seconds per package)
- Multiple packages: Non-porous, rigid, or flexible
- HLVD not influenced by protein presence

# Vacuum Decay, HVLD and Clogging

Detection effectiveness of defects “clogged” by proteinaceous products

## Leak detection VS Defect size & type

Hole size (μ)	Package contents	# Packages tested	# Packages ID'd as LEAKING	
			Vacuum decay	HVLD
15	Placebo	10	10	10
	Active	10	8	10
25	Placebo	10	10	10
	Active	10	9	10
50	Placebo	10	10	10
	Active	10	10	10

No helium leak tests were performed on holed vial packages post vacuum decay tests

S. Orosz, D. Guazzo, Glass vial finish defects - Leak detection and product risk assessment, PSIG session of the PDA Annual Meeting, Orlando, FL, March 16, 2010.

# Vacuum Decay, HVLD and Clogging

Detection effectiveness of defects “clogged” by proteinaceous products

## Leak detection VS Product formulation and storage time

Vial hole size (µ)	Packages tested (#)	# Packages ID'd as LEAKING DAY 1		# Packages ID'd as LEAKING DAY 29	
		Vacuum decay	HVLD	Vacuum decay	HVLD
<b>PRODUCT-FILLED</b>					
15	10	8	10	2	10
25	10	9	10	2	10
50	10	10	10	3	10
<b>PLACEBO-FILLED</b>					
15	10	10	10	10	10
25	10	10	10	10	10
50	10	10	10	10	10

S. Orosz, D. Guazzo, Glass vial finish defects - Leak detection and product risk assessment, PSIG session of the PDA Annual Meeting, Orlando, FL ,March 16, 2010

# Mass Extraction, HVLD and Clogging

Preliminary studies indicated that the “clogging” is most likely caused by proteinaceous drug (as opposed to other excipients or solution viscosity variations).

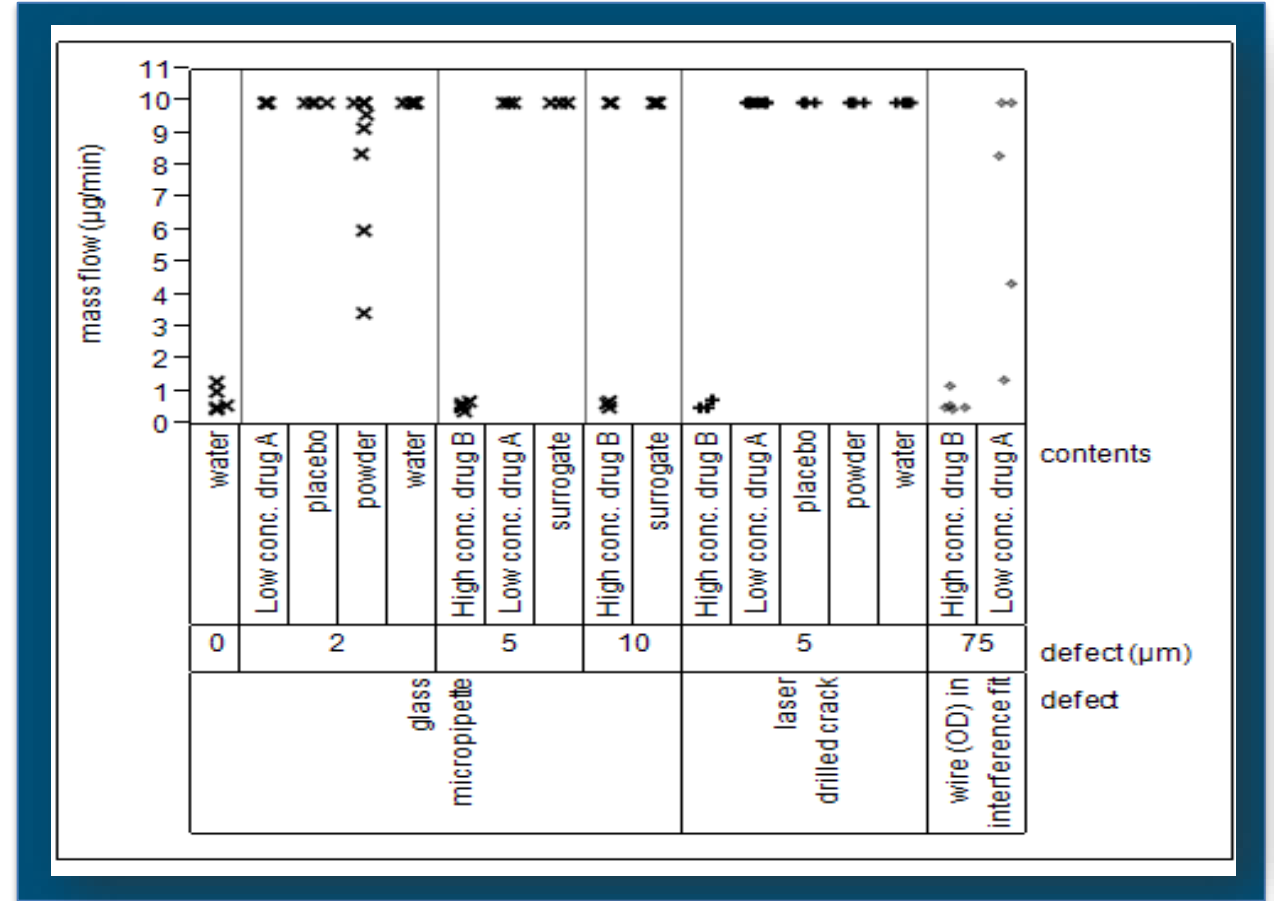

**Reference:** PDA J Pharm Sci and Tech 2012, 66 403-419

**Mass Extraction Container Closure Integrity Physical Testing Method Development for Parenteral Container Closure Systems;** by: SEUNG-YIL YOON<sup>1</sup>, HEMI SAGI, CRAIG GOLDHAMMER, and LEI LI

# Optical Emission Spectrometry

## O.E.S – Operating principle

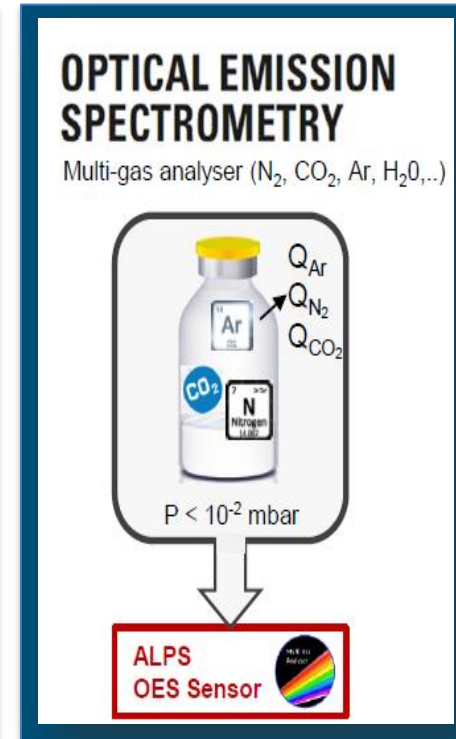
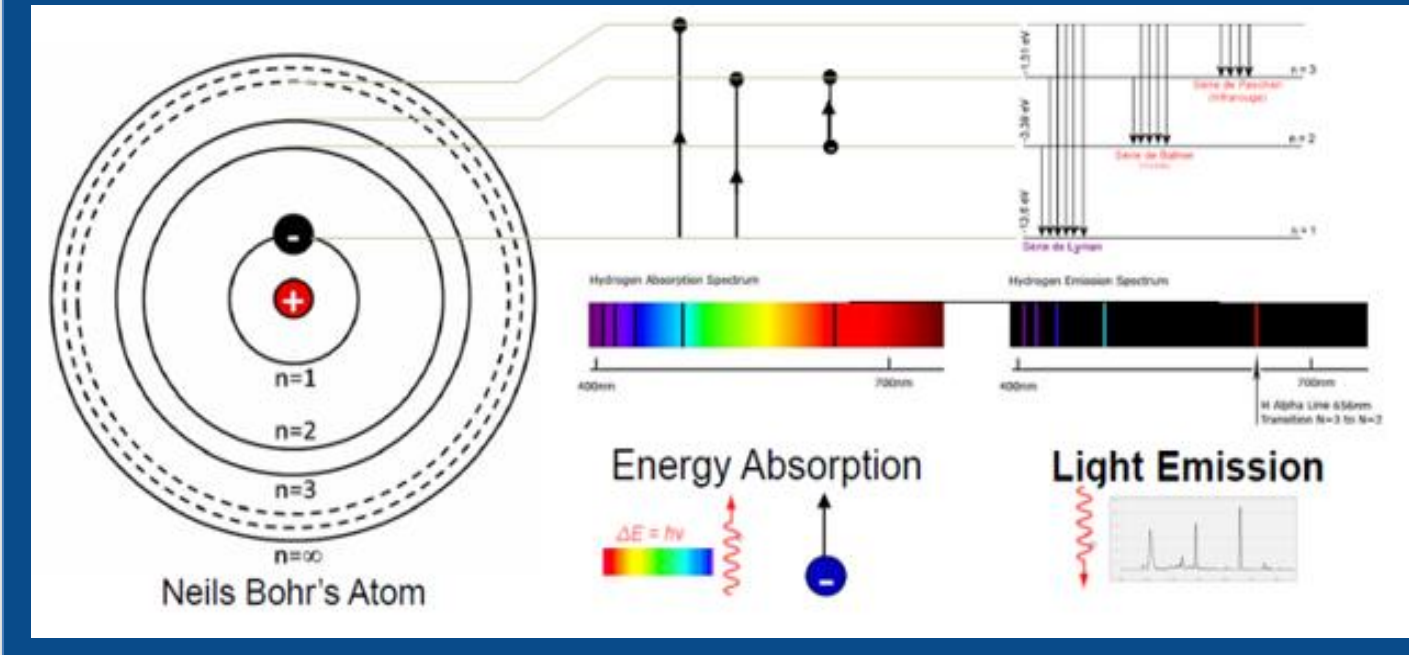

OES – widely used analytical technique used to determine elemental composition

Excitation to form a plasma which vaporizes, atomizes and ionizes material, followed by optical device that captures light, separate into spectral lines and measures it

Slides courtesy of Pfeiffer Vacuum

# Optical Emission Spectrometry

A Plasma is the 4<sup>th</sup> fundamental state of matter = hot ionized gas (instable).

Plasma de-excitation give light emission.

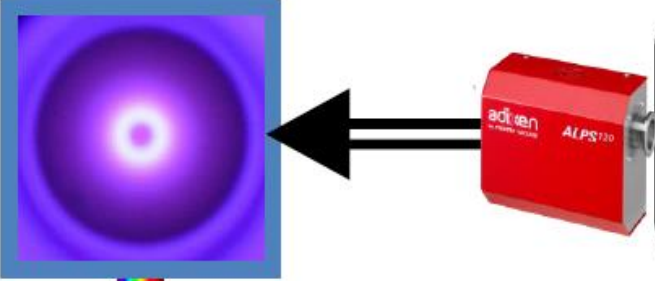

Test chamber ( $P < 5 \cdot 10^{-2}$  mbar)

Sealed component ( $N_2, Ar, CO_2 \dots$ )  $\rightarrow Q_{N_2}$  ( $atm \cdot cm^3/s$ )

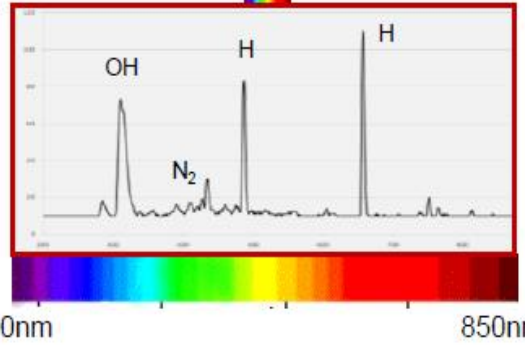



To detect leaks we are using our patented multi-gas "ALPS" sensor which is based on O.E.S.

OES – apply electrical energy in the form of a spark whereby the vaporized atoms are brought to a high energy state within the “plasma”. These excited atoms and ions in the plasma create a unique emission spectrum specific to each element

Slides courtesy of Pfeiffer Vacuum



# Optical Emission Spectrometry

## OES – Typical air leakage signal (raw data)

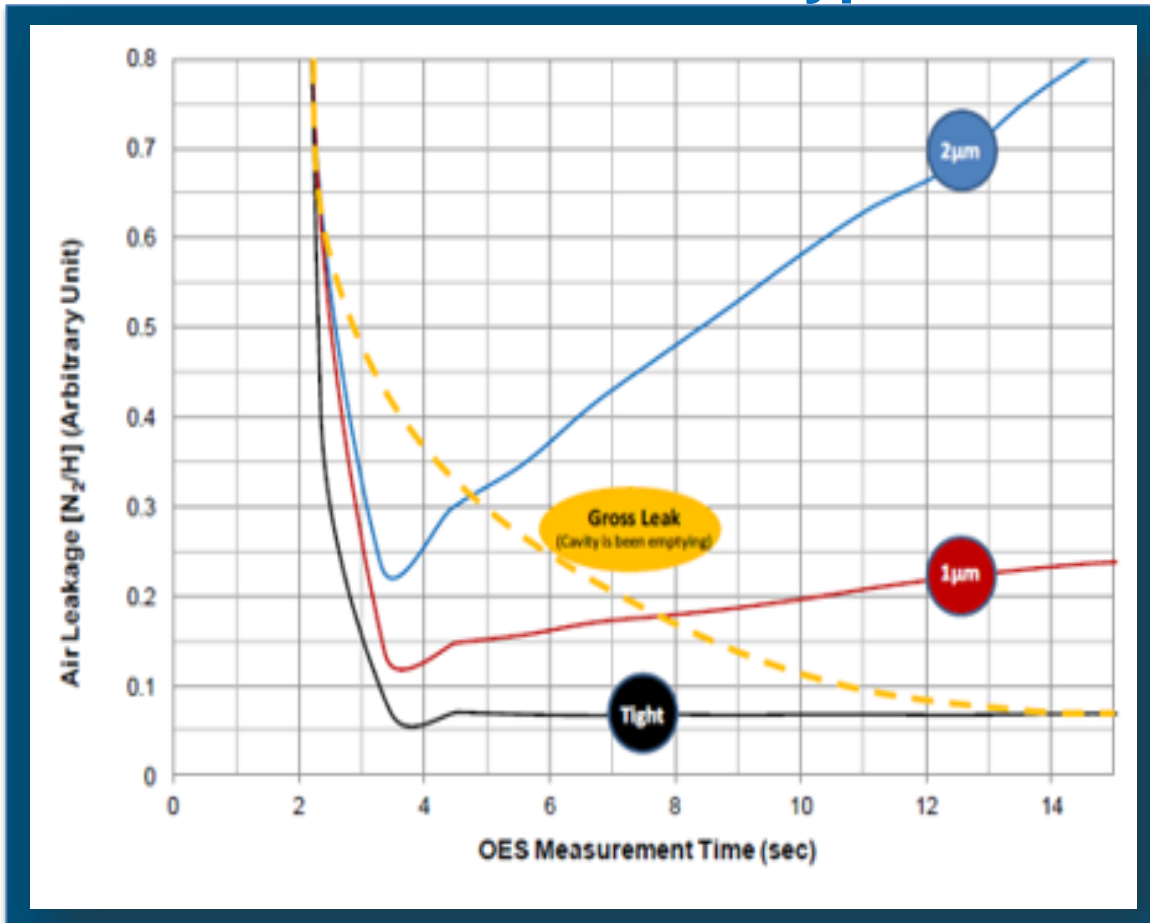

The air leakage corresponds to the intensity ratio [N<sub>2</sub>/H]

In case of fine leak, the air leakage signal (N<sub>2</sub>/H) increases as out-gassing (OH & H) is decreasing with time.

In case of gross leak (>100µm for 1cc headspace), depending on the headspace volume we can see the container being evacuated.

Slides courtesy of Pfeiffer Vacuum

# Optical Emission Spectrometry

## Limitations

- ❑ Out-gassing can limit the sensitivity
  - Minimize by design of container and test chamber; controlling conditions; increasing test duration
- ❑ Gross leak detection can be challenging in case of small gas headspace volume combined with low out-gassing solid drug
- ❑ Test fixture or restraint mechanism at test sample site of contact may block leak path
- ❑ Volatiles or liquids drawn into test system can cause damage
- ❑ Generally performed off-line
- ❑ Used in all product life cycle phases
- ❑ Requires several seconds to a minute per test sample

# Optical Emission Spectrometry

## Merits

- Non-destructive
- Sensitive
  - Sensitivity is not impacted by container expansion during test
    - Can be performed on semi-rigid containers
  - Sensitivity is not impacted by the free space in the chamber around the container
    - Test of complex design devices i.e., autoinjectors
    - Possibility to test per batch to increase throughput)
- No sample preparation
- Fast analysis ~ 15 seconds
- Method is not volume dependent – same size defect can be detected in a batch of 10 vials or in a single vial in the same test chamber